



AIR BRAKE &
CLUTCH SERVO
SYSTEMS

www.ifn-auto.com

2012 CATALOGUE



Number System / Numara Sistemi

75 . 609 . 00 . 2

0 - Units
1 - Parts
2 - Repair Kit

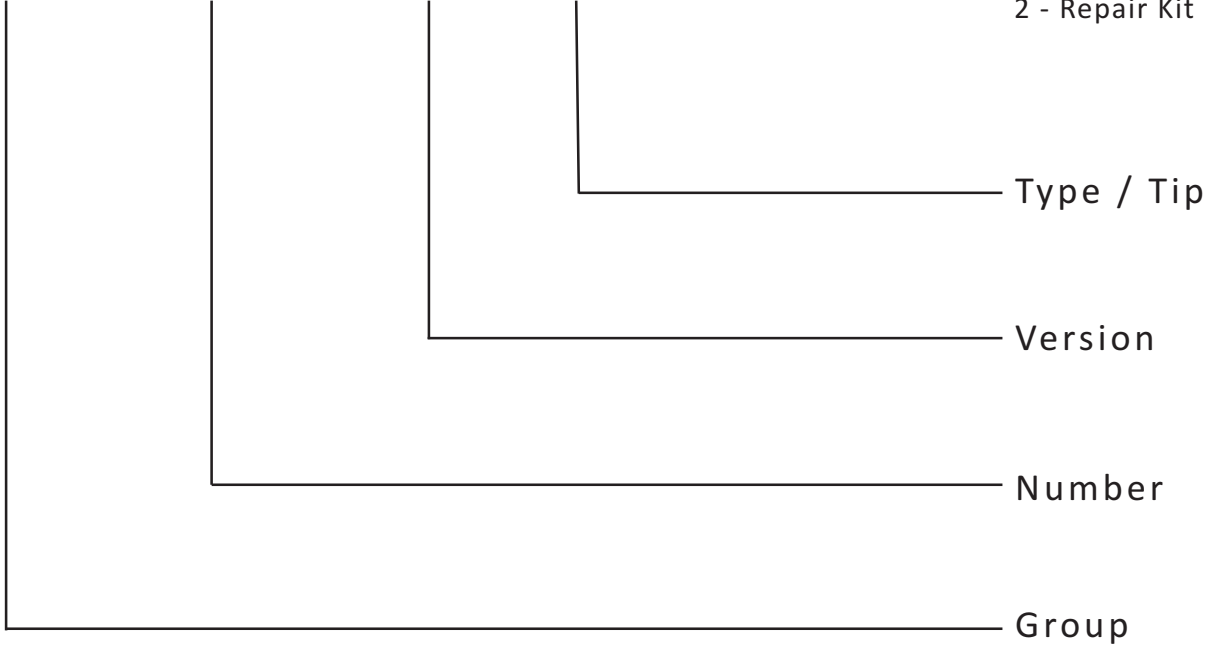

Look At Group Page



Labels Coming With QR Code / QR Kodlu Yeni Etiketler

75.609.00.2
Load Sensing Valve Rep.Kit

475 710 001 2

IFN75609002 M.I.TURKIYE

In This QR Code we put all information of the kit and provide tracking parametres



GROUPS

10

UNLOADER VALVES



20

FOOT BRAKE VALVES



30

HAND BRAKE VALVES



40

TRAILER CONTROL VALVES



45

RELAY VALVES



55

CIRCUIT PROTECTION VALVES

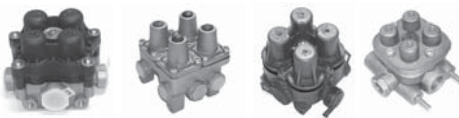

60

SPRING BRAKES



70

LEVELLING VALVES



75

LOAD SENSING VALVES



80

AIR DRYERS



90

CLUTCH SERVOS



95

GEAR BOX UNITS



100

SELENOID GROUP



100

OTHERS



105

CALIPERS



110

COMPRESSORS



IMPORTANT NOTICE

All the original numbers included in this catalogue are cross reference purposes only and must not be used at the commercial invoices.

Parts supplied by IFN are alternatives to the original. IFN produces its own product with its own brand name and package.

The photographed contents are followed as closely as possible, but not guaranteed.

The information in this catalogue has been arranged carefully but it may carry some mistakes and we don't take responsibility of them.

No part of this publication may be reproduced without our written special permission.

At some countries, we know that, there are duplicated IFN items. Please be carefull to buy the items from the authorized dealers and/or send information about these kind of situations to ifn@ifn-auto.com

ÖNEMLİ UYARI

Bu katalogta kullanılan tüm orijinal numaralar sadece geçiş kolaylığı sağlamak içindir ve ticari evrakta kullanılmamalıdır.

İFN'nin sattığı ürünler orijinalin alternatifidir.İFN kendi ürününü üretir ve kendi markası ve paketiyle satar.

Kullanılan fotoğraflar mümkün olduğunca ürünü yansıtmaktadır ama içerik garanti edilemez.

Bu katalogtaki bilgiler büyük bir titizlikle hazırlanmıştır ancak hatalar bulunabilir ve bu hatalardan firmamız sorumlu değildir.

Bu kataloğun hiç bir parçası ya da tamamı yazılı özel iznimiz olmadan kopyalanamaz.

Bazı ülkelerde taklit İFN ürünlerinin olduğunu biliyoruz. Lütfen ürünü yetkili satıcılarımızdan almaya dikkat ediniz ve böyle durumları bize ifn@ifn-auto.com email adresinden bildiriniz.



10

UNLOADER VALVES

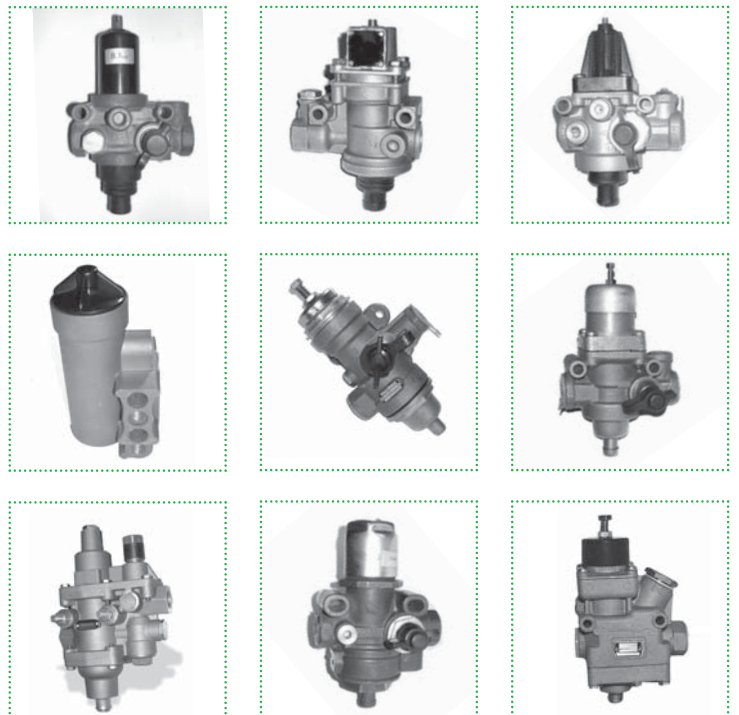

10.522

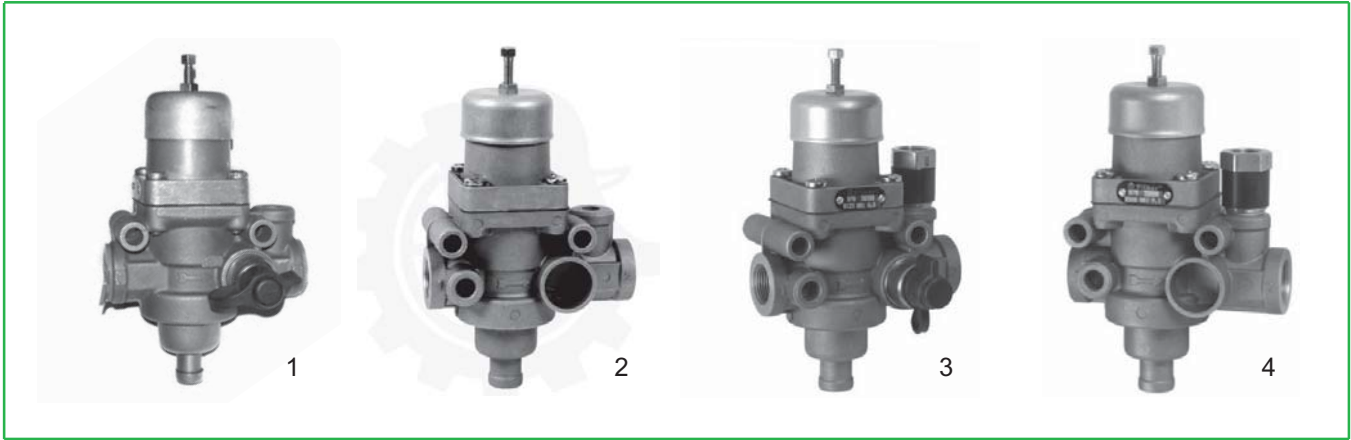
Unloader Valve
Hava Tahliye Valfi

İFN No	Ref. No	Fig.	Cut-Out Pressure	Notes
10.522.110.0	975 300 110 0	1	8,1 Bar	With Tyre Inflector/Teker Şişiricili
10.522.111.0	975 300 111 0	1	7,3 Bar	With Tyre Inflector
10.522.112.0	975 300 112 0	1	7,8 Bar	With Tyre Inflector
10.522.156.0	975 300 156 0	1	8,5 Bar	With Tyre Inflector
10.522.014.0	975 300 014 0	2	8,1 Bar	Without Tyre Inflector
10.522.502.0	975 300 502 0	3	8,0 Bar	With Tyre Inflector
10.522.550.0	975 300 550 0	4	9,3 Bar	Without Tyre Inflector
10.522.551.0	975 300 551 0	4	8,5 Bar	Without Tyre Inflector

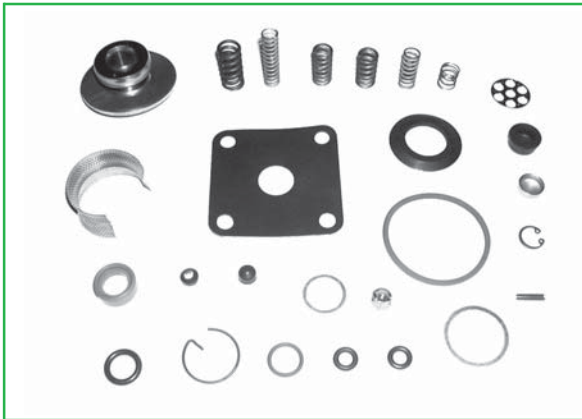
**10.522.00.2**

975 300 000 2

10.522.01.2

975 300 001 2

For ALL
975 300 --> series

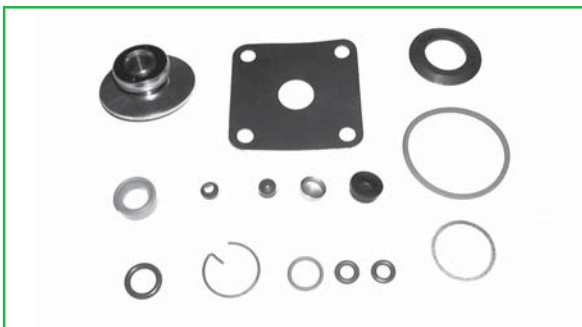
**10.522.02.2**

975 300 *** 2

Half Kit

10.552

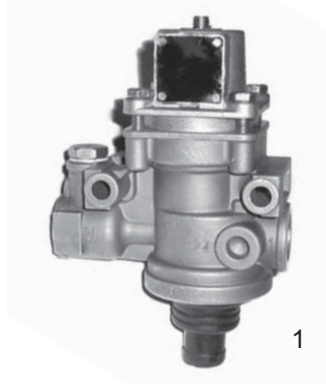
 Unloader Valve
Hava Tahliye Valfi

IFN No	Ref. No	Fig.	Cut-Out Pressure	Notes
10.552.201.0	0 481 039 201	1	8,1 Bar	With Tyre Inflector
10.552.202.0	0 481 039 202	1	7,3 Bar	With Tyre Inflector
10.552.210.0	0 481 039 210	1	8,0 Bar	With Tyre Inflector
10.552.240.0	0 481 039 240	1	8,5 Bar	With Tyre Inflector
10.552.218.0	0 481 039 218	1	7,8 Bar	With Tyre Inflector
10.552.209.0	0 481 039 209	1	8,1 Bar	With Tyre Inflector In Connection With Air Dryer
10.552.213.0	0 481 039 213	1	10,0 Bar	With Tyre Inflector In Connection With Air Dryer
10.552.241.0	0 481 039 241	1	8,5 Bar	With Tyre Inflector In Connection With Air Dryer



10.552.01.2

1 487 010 165

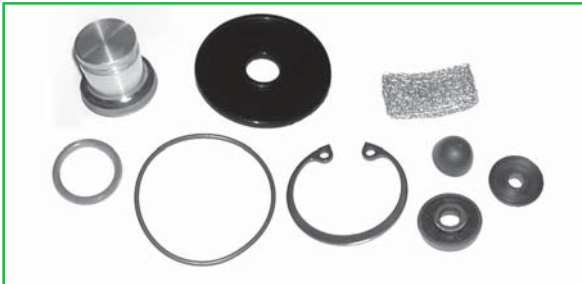

10.552.03.2

1 487 010 165



10.552.04.2

10.621

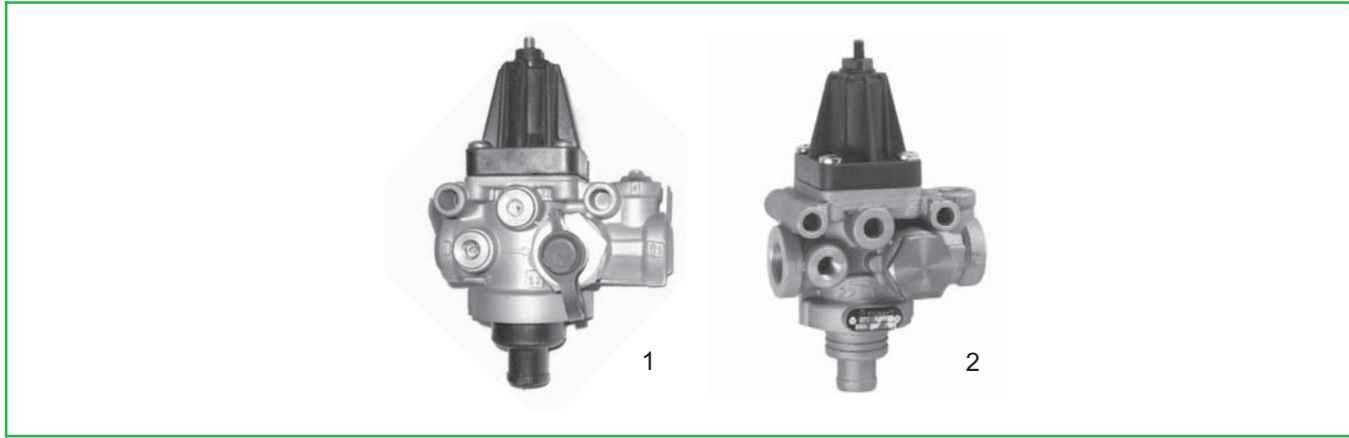
Unloader Valve
Hava Tahliye Valfi

İFN No	Ref. No	Fig.	Cut-Out Pressure	Notes
10.621.473.0	975 303 473 0	1	8,1 Bar	With Tyre Inflector/Teker Şişiricili
10.621.060.0	975 303 060 0	2	8,1 Bar	Without Tyre Inflector
10.621.474.0	975 303 474 0	1	8,1 Bar	With Tyre Inflector In Connection With Air Dryer
10.621.504.0	975 303 504 0	1	10 Bar	With Tyre Inflector In Connection With Air Dryer
10.621.081.0	975 303 081 0	2	9,5 Bar	Without Tyre Inflector
10.621.447.0	975 303 447 0	1	7,3 Bar	With Tyre Inflector In Connection With Air Dryer
10.621.085.0	975 303 085 0	1	9,5 Bar	With Tyre Inflector In Connection With Air Dryer
10.621.441.0	975 303 441 0	1	7,8 Bar	With Tyre Inflector
10.621.463.0	975 303 463 0	1	8,5 Bar	With Tyre Inflector
10.621.472.0	975 303 472 0	1	8,0 Bar	With Tyre Inflector In Connection With Air Dryer
10.621.541.0	975 303 541 0	1	12 Bar	With Tyre Inflector In Connection With Air Dryer
10.621.072.0	975 303 072 0	1	8,5 Bar	With Tyre Inflector In Connection With Air Dryer
10.621.082.0	975 303 082 0	2	9,8 Bar	Without Tyre Inflector
10.621.120.0	975 303 120 0	2	11 Bar	Without Tyre Inflector
10.621.469.0	975 303 469 0	2	8,5 Bar	Without Tyre Inflector

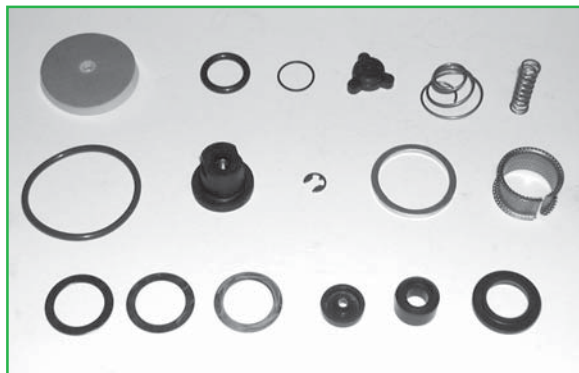

10.621.00.2

975 303 001 2

10.621.01.2

975 303 001 2



10.621.02.2

975 303 *** 2

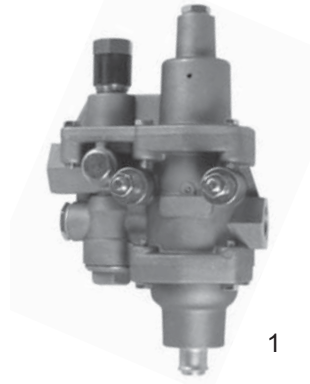
10.470
Unloader Valve
Hava Tahliye Valfi

1

İFN No	Ref. No	Fig.	Cut-Out Pressure	Notes
10.470.00.0	133 527 92 08	1		

10.470.00.2
720 199 00 08

FOR RENAULT

100.598
Unloader Valve
Hava Tahliye Valfi

1

İFN No	Ref. No	Fig.	Cut-Out Pressure	Notes
100.598.00.0	275491	1		Plastic Cap

100.598.01.2
SK 2612-1

10.467

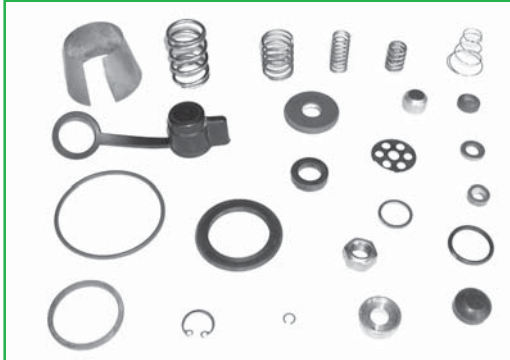
Unloader Valve
Hava Tahliye Valfi

10.467.00.2

1 61090

10.500

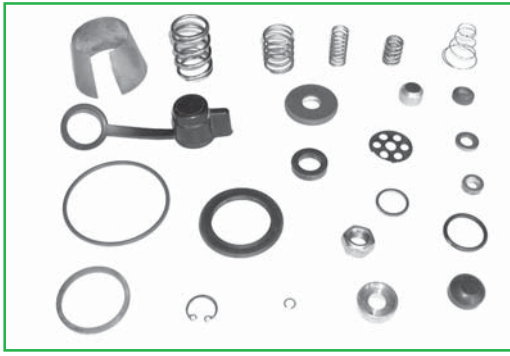
Unloader Valve
Hava Tahliye Valfi

10.500.01.2

475 304 004 2

10.552

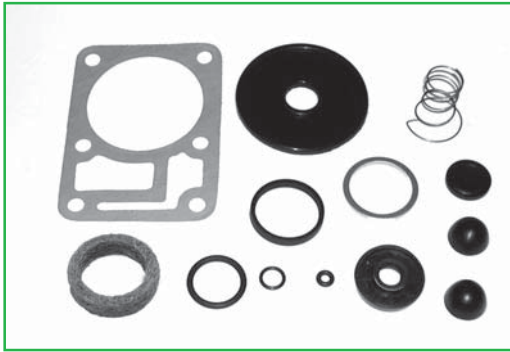
Unloader Valve
Hava Tahliye Valfi

10.552.00.2

1 487 010 163

10.500

Unloader Valve
Hava Tahliye Valfi

10.664.00.2

1 87546

20

FOOT BRAKE VALVES

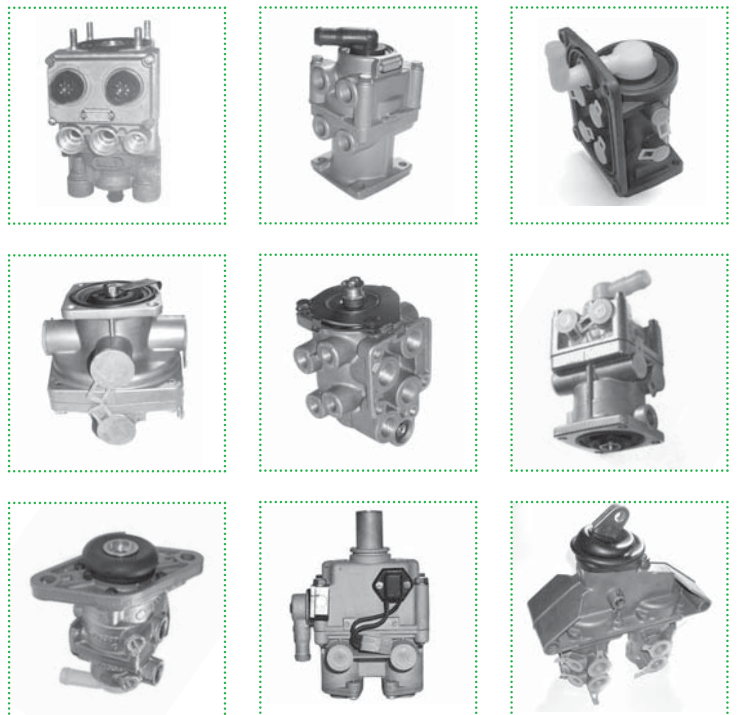

20.507

Foot Brake Valve
Fren Pedal Valfi

1



2

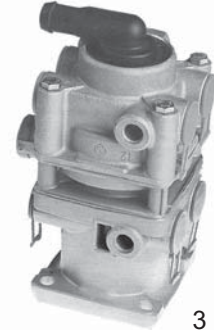

3

İFN No	Ref. No	Fig.	Cut-Off Pressure	Notes
20.507.008.0	461 315 008 0	1	10 Bar	8 x (M16 * 1,5)
20.507.042.0	461 315 042 0	1	10 Bar	8 x (M 16 * 1,5) 2 x (M12 * 1,5)
20.507.004.0	461 315 004 0	1	10 Bar	8 x (M 16 * 1,5) 2 x (M12 * 1,5)
20.507.150.0	461 315 150 0	1	10 Bar	4 x (M 16 * 1,5)
20.507.491.0	461 315 491 0	1	10 Bar	4 x (M 16 * 1,5)
20.507.012.0	461 315 012 0	2	10 Bar	8 x (M 16 * 1,5)
20.507.017.0	461 315 017 0	2	10 Bar	4 x (M 16 * 1,5) 2 x (M12 * 1,5)
20.507.036.0	461 315 036 0	2	10 Bar	4 x (M 16 * 1,5)
20.507.482.0	461 315 482 0	2	10 Bar	4 x (M 16 * 1,5) 2 x (M12 * 1,5)
20.507.497.0	461 315 497 0	2	10 Bar	4 x (M 16 * 1,5) 2 x (M12 * 1,5)
20.507.908.0	461 319 008 0	3	10 Bar	With Plate
20.507.918.0	461 319 018 0	3	10 Bar	With Plate
20.507.928.0	461 319 028 0	3	10 Bar	With Plate
20.507.932.0	461 319 032 0	3	10 Bar	With Plate

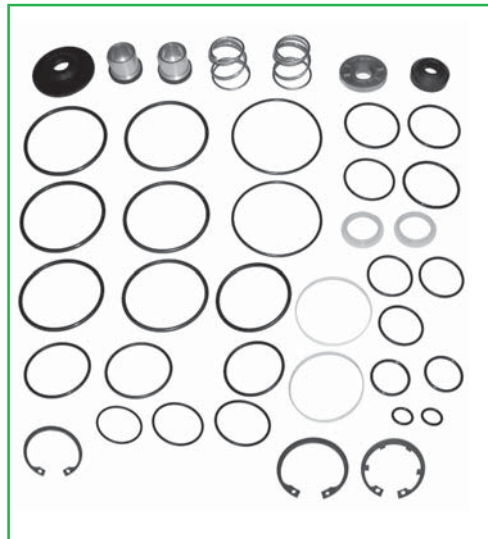

20.507.50.2

Replaces / Şu takımların yerine geçer:

20.507.02.2	461 315 002 2
20.507.03.2	461 315 003 2
20.507.04.2	461 315 004 2
	461 315 928 2
20.507.05.2	461 315 005 2
	461 315 915 2
20.507.06.2	461 315 008 2
	461 315 916 2
20.507.11.2	461 315 905 2
	461 315 922 2
20.507.12.2	461 315 906 2
	461 315 923 2
	461 315 908 2
	461 315 925 2
	461 315 914 2
	461 315 927 2
20.507.13.2	461 319 001 2
20.507.14.2	461 319 002 2
	461 319 003 2
20.507.16.2	461 319 005 2
20.507.18.2	461 319 007 2
20.507.19.2	461 319 008 2
	461 319 909.2

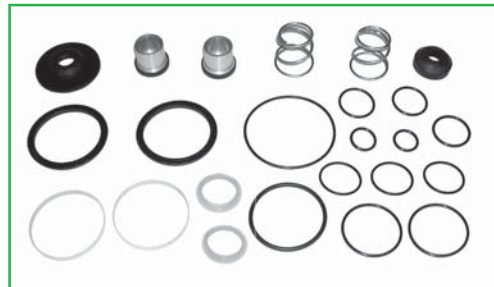

20.507.51.2 Seal Type / Keçeli Model

Replaces / Şu takımların yerine geçer:

20.507.07.2	461 315 917 2
	461 315 900 2
20.507.08.2	461 315 901 2
20.507.09.2	461 315 902 2
	461 315 920 2
20.507.10.2	461 315 904 2
20.507.20.2	461 319 009 2

20.507

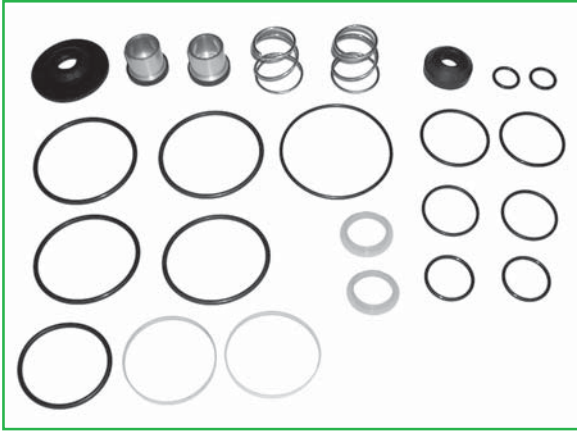
 Foot Brake Valve
Fren Pedal Valfi

20.507.05.2

461 315 005 2

Eski model valflerde **3.53 * 63.09**
 yeni model valflerde **3.00 * 64.00**
 Takımda her iki o-ring de bulunmaktadır.

At the old model valves **3.53 * 63.09**
 At the new model valves **3.00 * 64.00**
 Both of these o-rings are included in our kits.

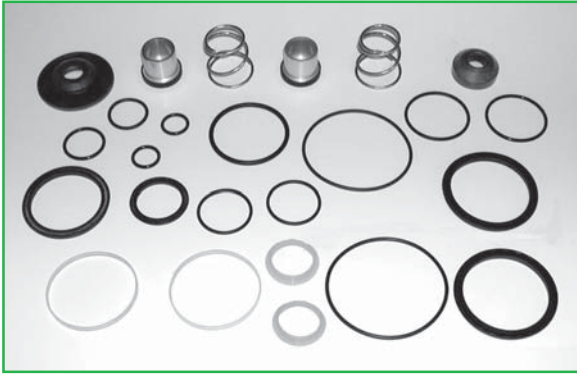

20.507.15.2

461 319 004 2

20.507.15.2

461 319 004 2

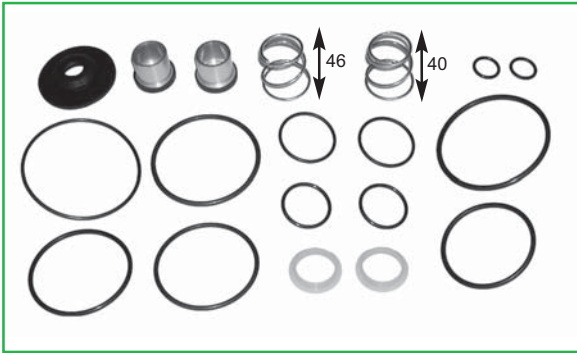

20.507.22.2

461 315 907 2

For 461 315 180 0



20.512

 Foot Brake Valve
Fren Pedal Valfi

20.512.00.2

For:
0 486 200 005

RENAULT

20.101 / 20.110 / 20.120

Foot Brake Valve
Fren Pedal Valfi

20.101.00.2

289352

E7



20.110.00.2

287368

E6



20.120.00.2

276119

E2 & E3



20.482

Foot Brake Valve
Fren Pedal Valfi

20.482.04.2

17237*

Replaces / Şu takımların yerine geçer:

20.482.00.2	159347
20.482.01.2	167711
20.482.02.2	172375
20.482.03.2	155719 / 0051

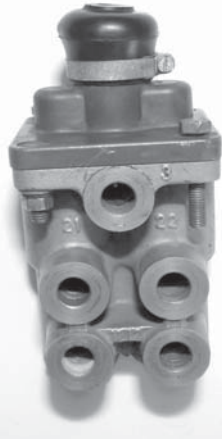

MB 44**



20.200 / 20.634

Foot Brake Valve
Fren Pedal Valfi



APGA 662*

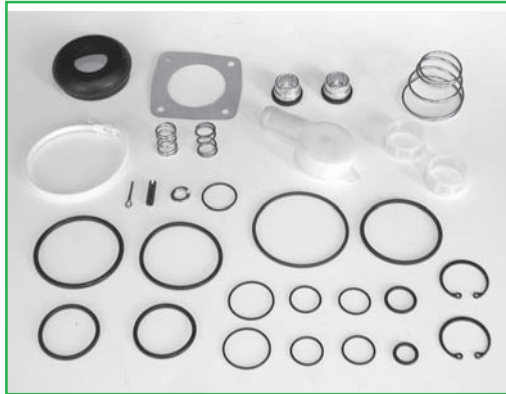

20.200.00.2

GA 29302

For
APGA 662*
FORD CARGO
Alüminyum Piston

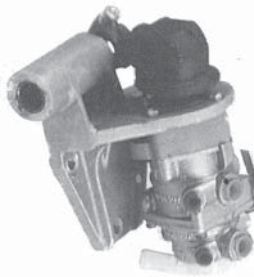

APGA 671*



20.634.00.2

GA 29283

20.314 / 20.573

Foot Brake Valve
Fren Pedal Valfi

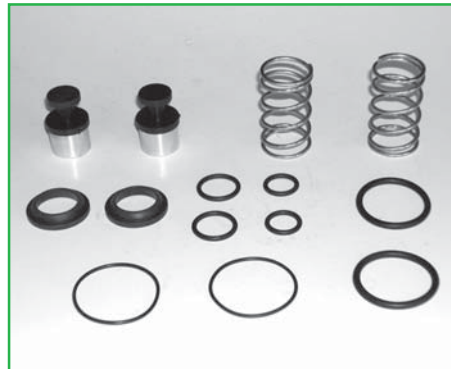
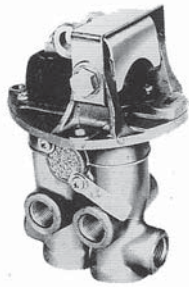

20.314.00.2

SK 2764-1

FOR
SCANIA

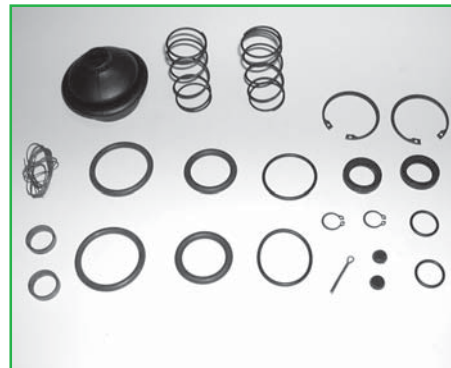

20.573.00.2

461 499 000 2

20.573.01.2

461 499 *** 2



With Plastic Pistons
Plastik Pistonlu

20.508

Foot Brake Valve
Fren Pedal Valfi

1



2

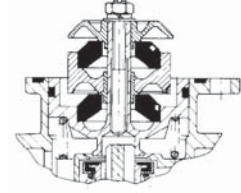

Double rubber Mounting

461 307 383 0
 461 307 399 0
 461 307 471 0
 461 307 474 0
 461 307 494 0

IFN No	Ref. No	Fig.	Working Pressure	Notes
20.508.479.0	461 307 479 0	1	8 Bar	MERCEDES MAN DAF VOLVO SCANIA IVECO
20.508.407.0	461 307 407 0	1	8 Bar	VOLVO

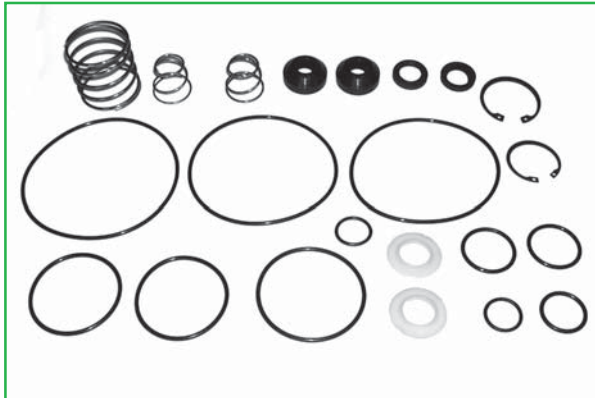
**20.508.00.2**

461 307 002 2

Replaces
 461 307 004 2
 20.508.02.2 461 106 000 2

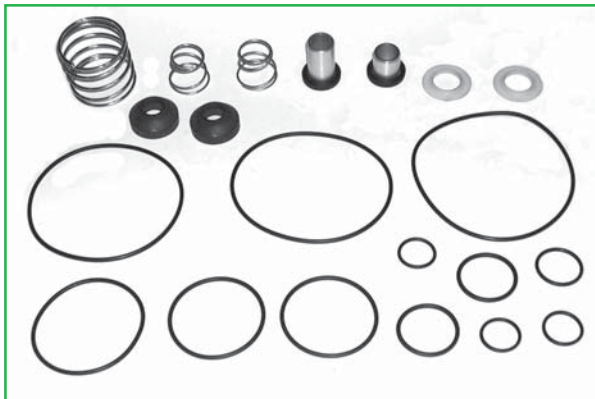
**20.508.03.2**

461 307 *** 2

Pistonlu takım
 Kit with pistons

20.685

Foot Brake Valve
Fren Pedal Valfi

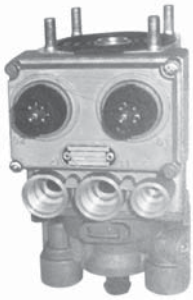

480 001 000 0
480 001 010 0
ACTROS

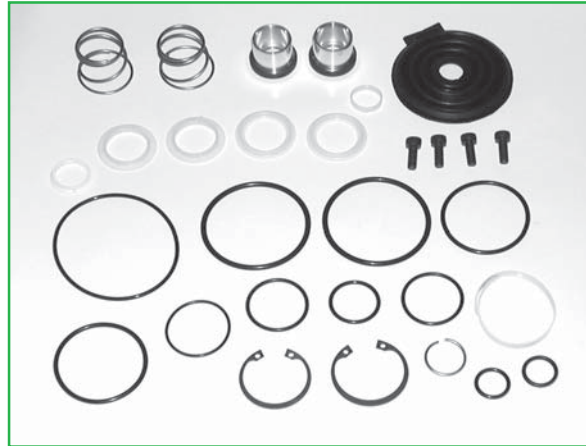

20.685.00.2

FOR
MERCEDES ACTROS
IVECO STRALIS

20.648

Foot Brake Valve with EBS
EBS li Fren Pedal Valfi

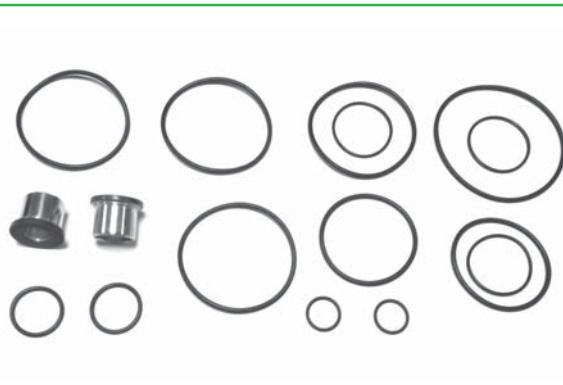

20.648.00.2

FOR
SCANIA(1324664)
ALSO FOR
0 486 200 008

20.306

Foot Brake Valve
Fren Pedal Valfi

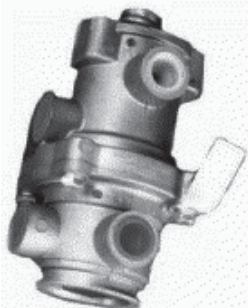

APSA 7314



20.306.00.2

GA 29102

FOR
SCANIA

20.594

Foot Brake Valve
Fren Pedal Valfi

0 481 064 005



0 481 064 115

**20.594.00.2**

1 487 010 *60

**20.594.01.2**

1 487 010 060

**20.594.02.2****Common Kit**

For

0 481 064 006
 0 481 064 101
 0 481 064 102
 0 481 064 105
 0 481 064 115
 0 481 064 201
 0 481 064 202
 0 481 064 203
 Use This Kit

This kit replaces

1 487 010 060
 1 487 010 338
 1 487 010 181
 1 487 010 182
 1 487 010 183

20.647

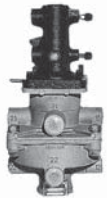
Foot Brake Valve
Fren Pedal Valfi

0 481 064 001



0 481 064 003

**20.647.00.2**

1 487 010 178

For

0 481 064 001
 0 481 064 002
 0 481 064 007
 0 481 064 008
 0 481 064 013

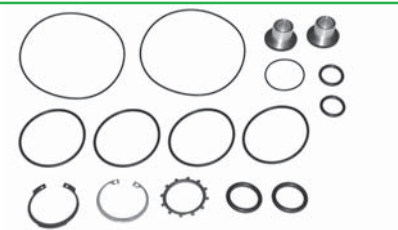
**20.647.01.2**

1 487 010 179

For

0 481 064 003

20.671

Foot Brake Valve
Fren Pedal Valfi



20.671.00.2

1 80450

Replaces
1 83842

For
MB 4630-I 74907

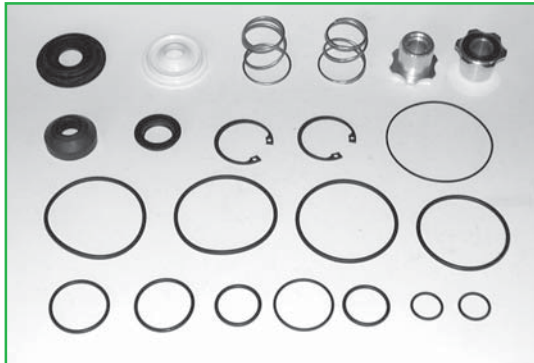

20.671.01.2

1 83121

For
MB 4630-I 76624

Aluminium Piston

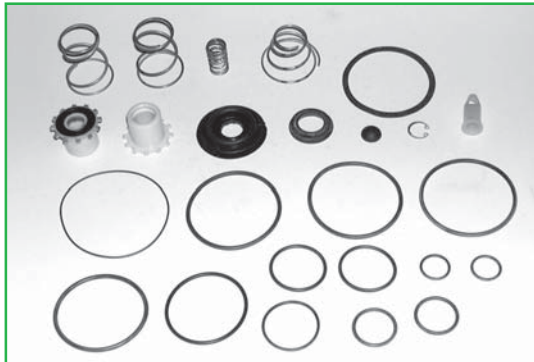

20.671.02.2

1 99719 / 008

For
MB 4690

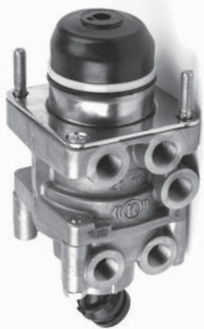

20.671.10.2

1 90694

For
MB 4673
MB 4674
MB 4679
MB 4803
MB 4804

Aluminium Piston

20.674 / 20.676

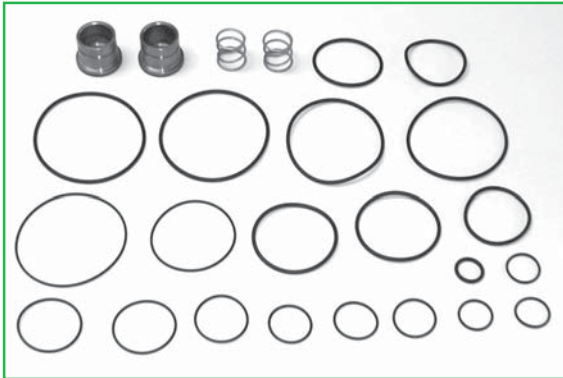
Foot Brake Valve
Fren Pedal ValfiDX 70 A
DX 70 C**20.674.00.2**

76636702

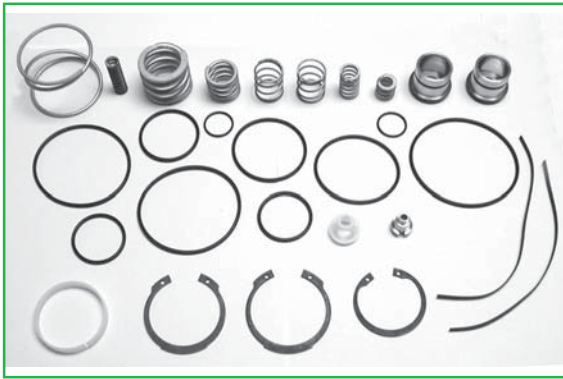
For
DX 70 A
DX 70 C**20.674.01.2**

766308020

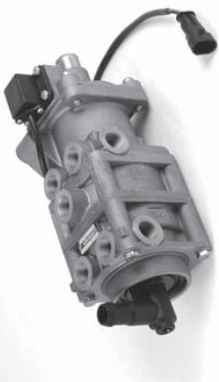
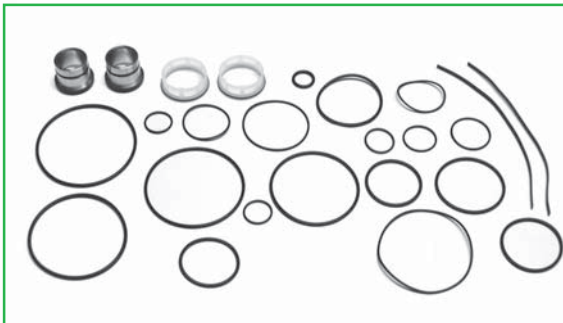
DX 75
DX 95**20.676.00.2**

76620002

Replaces
76620001

For

DX 65 CX	DX 75 BXU
DX 75 B	DX 75 BXY
DX 75 BA	DX 95 B
DX 75 BARM	DX 95 BRM
DX 75 BAXU	DX 95 BX
DX 75 BAY	DX 95 BXU
DX 75 BRM	DX 95 BXY
DX 75 BX	DX 95 BY

**20.676.01.2**

76620102

Replaces
76620101

IVECO

20.509

Foot Brake Valve Fren Pedal Valfi



20.509.00.2

461 494 923 2

RENAULT VI Premium

20.510

Foot Brake Valve Fren Pedal Valfi

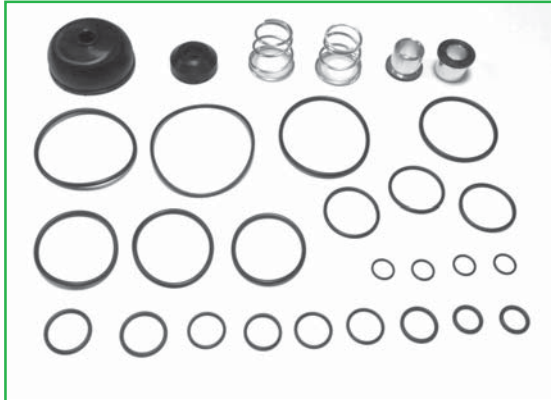
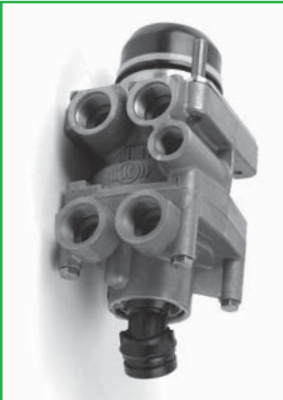

20.510.00.2

320060002

GRAU-HALDEX
KNORR MB4815

20.511

Foot Brake Valve Fren Pedal Valfi



20.511.00.2

461 315 927 2

İnce sibop
Thin Piston

30

HAND BRAKE VALVES

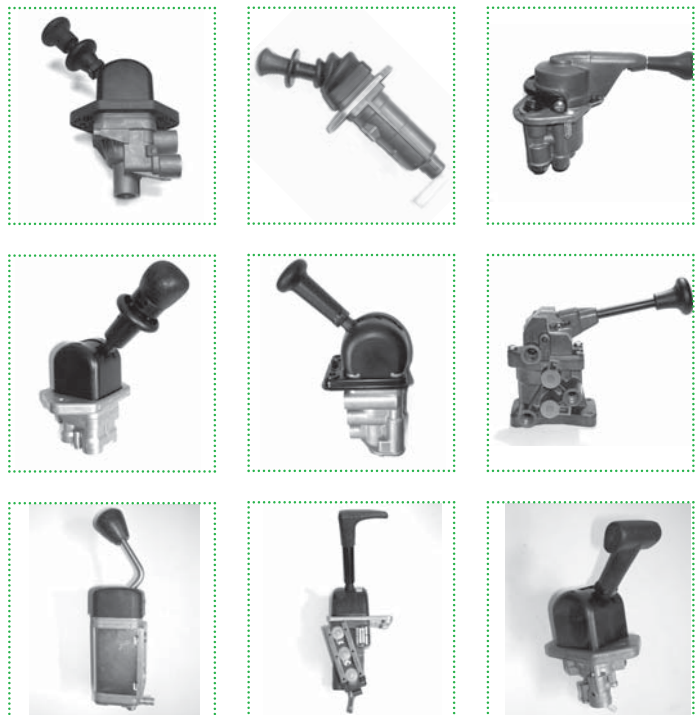

30.673
Hand Brake Valve
El Fren Valfi



IFN No	Ref. No	Techn'cal	Notes
30.673.142.0	HB 1142	Without Pipe	MAN
30.673.143.0	HB 1143	With Pipe	MAN / VOLVO / IVECO / MAGIRUS
30.673.176.0	HB 1176	With Pipe	MAN / VOLVO / IVECO / MAGIRUS
30.673.258.0	HB 1258	With Pipe	MAN / IVECO / MAGIRUS
30.673.350.0	HB 1350	Without Pipe	MAN

30.673.00.2
*17237**

30.673.02.2
172371

30.556

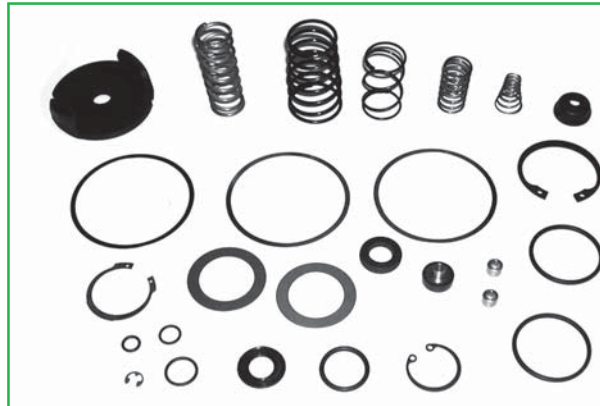
Hand Brake Valve
El Fren Valfi



30.556.00.2

961 703 000 2

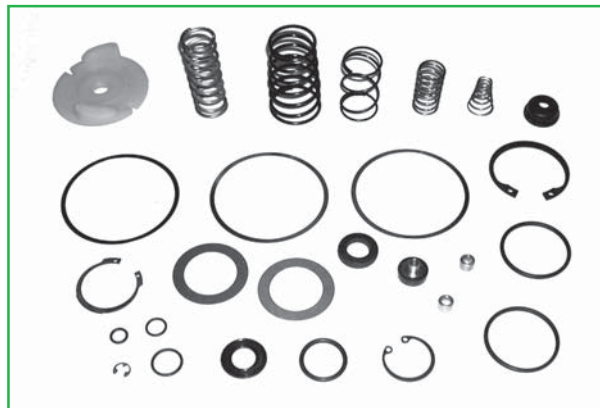

30.556.06.2

961 702 000 2



30.556.03.2

961 701 000 2

30.222

Hand Brake Valve
El Fren Valfi

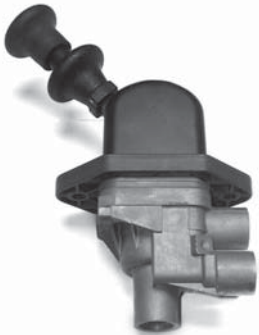

DPM 22
DPM 23
DPM 24



30.222.00.2

AXOR
ATEGO
ACTROS

30.223

Hand Brake Valve
El Fren Valfi

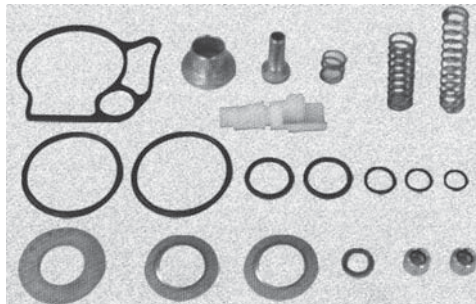
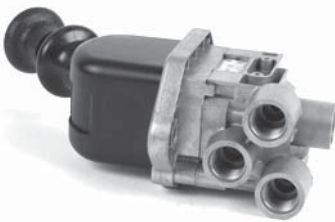

30.223.00.2

ACTROS

30.220

Hand Brake Valve
El Fren Valfi

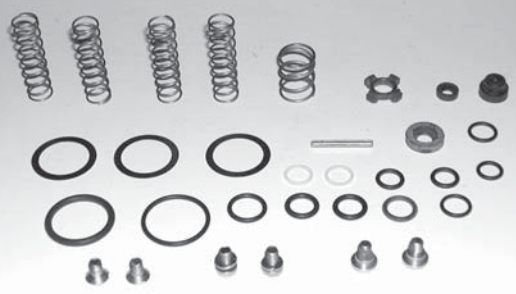

30.220.00.2

192180/008

For:
HB 1167
HB 1172

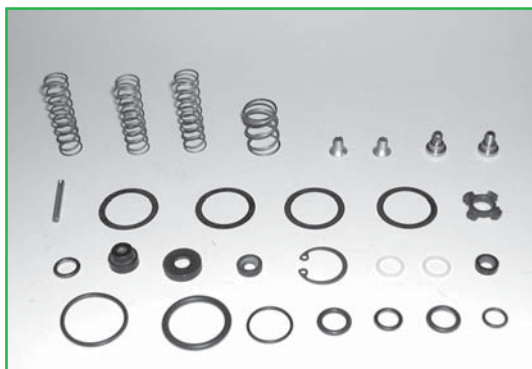

30.220.01.2

192181/008

For:
HB 1168
HB 1173

30.590

Hand Brake Valve
El Fren Valfi

İFN No	Ref No	Fig	Notes
30.590.210.0	961 722 210 0	2	MERCEDES
30.590.252.0	961 722 252 0	1	MERCEDES-DAF

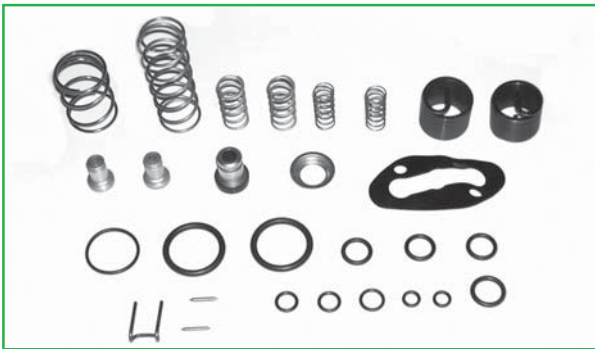

30.590.00.2

961 722 004 2

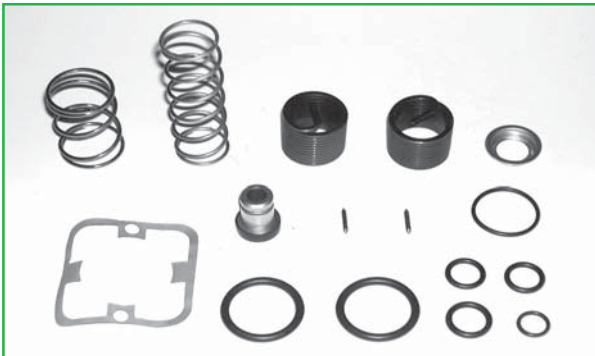

30.590.01.2

961 722 002 2

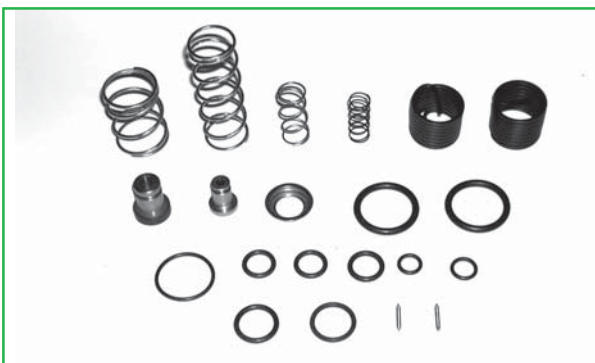

30.590.02.2

961 722 003 2

Other Available Repair Kits Diğer Mevcut Olan Takımlar

30.590.03.2	961 722 007 2
30.590.04.2	961 722 000 2
30.590.05.2	961 722 005 2
30.590.06.2	961 722 006 2

30.566

Hand Brake Valve
El Fren Valfi



0 481 016 209

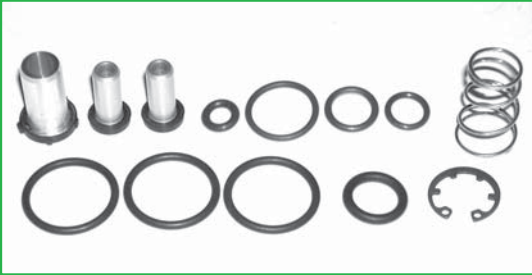

30.566.00.2



30.566.01.2

1 487 010 160



30.566.02.2

1 487 010 272

30.596

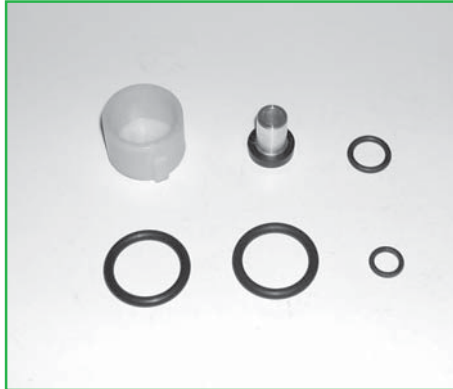
Hand Brake Valve
El Fren Valfi

30.596.00.2

961 721 *** 2

30.584

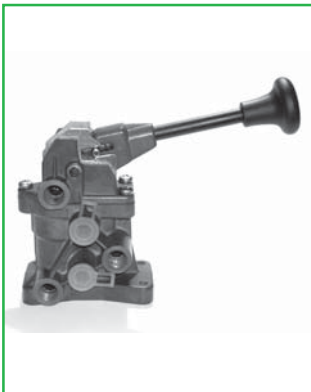
Hand Brake Valve
El Fren Valfi

30.584.00.2

172290

 For
 MAN (81 52315 6056)

30.201

Hand Brake Valve
El Fren Valfi

APGA 6635 A



30.201.00.2

GA 29144

30.675

Hand Brake Valve
El Fren Valfi



961 723 100 0



961 723 001 0

IFN No	Ref No	Details	Notes
30.675.100.0	961 723 100 0	3 * M16 * 1,5	MAN, KAMAZ
30.675.001 0	961 723 001 0	2 * M16 * 1,5	DAF
30.675.112.0	961 723 112 0	3 * M16 * 1,5	MAN
30.675.102 0	961 723 102 0	3 * M16 * 1,5	RVI, MERCEDES, VOLVO, MAN, IVECO, DAF
30.675.005 0	961 723 005 0	2 * M16 * 1,5	DAF, MERCEDES, IVECO



30.675.00.2

961 723 000 2

Replaces 961 723 003 2



30.675.01.2

961 723 001 2

Replaces 961 723 002 2



30.675.02.2

961 723 004 2

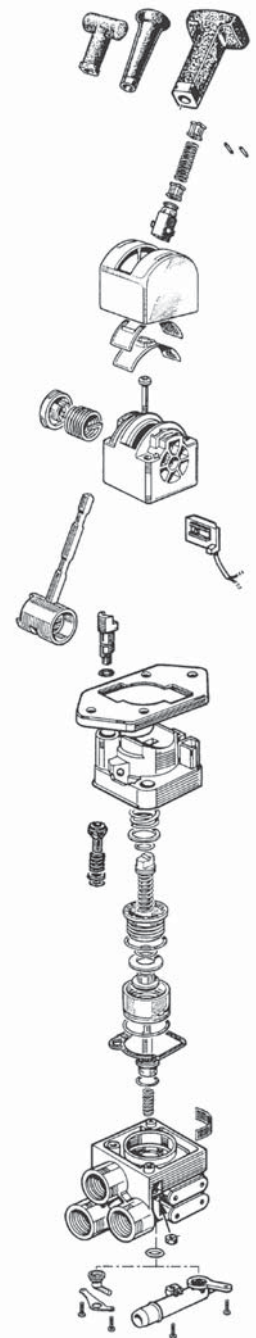

30.210

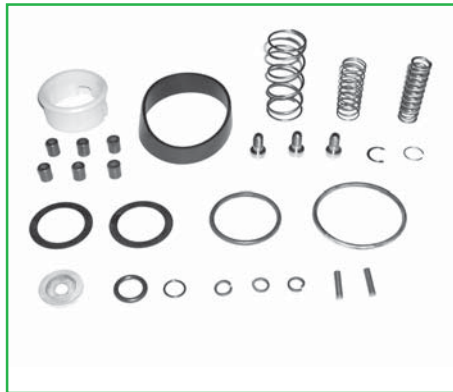
Hand Brake Valve
El Fren Valfi
**30.210.00.2**

/ 72376

For:
 HB 1110
 HB 1135
 HB 1136

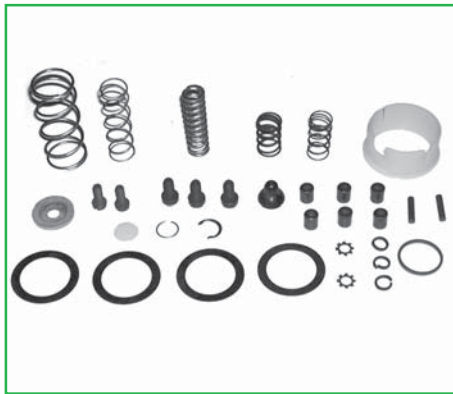
**30.210.01.2**

/ 80557

HB 1140

40

TRAILER CONTROL VALVES

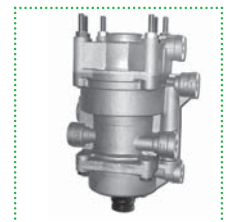

40.145 / 40.155

Trailer Control Valve
Dorse Kontrol Valfi

973 009 *** 0

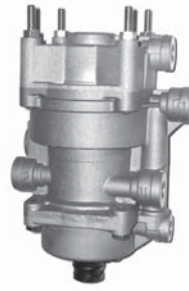

973 008 *** 0

IFN No	Ref No	Notes
40.145.010.0	973 009 010 0	SCANIA
40.145.004.0	973 009 004 0	MERCEDES
40.145.002.0	973 009 002 0	IVECO,VOLVO
40.145.001.0	973 009 001 0	MERCEDES,DAF
40.155.002.0	973 008 002 0	DAF

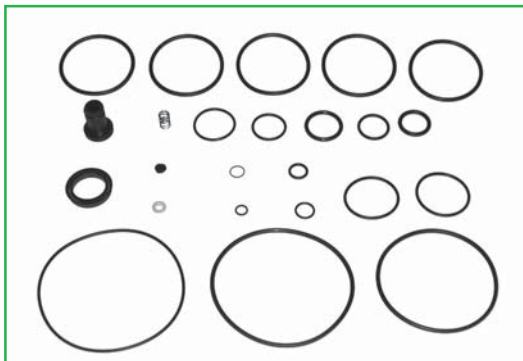

40.145.00.2

973 009 000 2



40.155.00.2

973 008 001 2

For:
 973 008 002 0
 973 008 003 0
 973 008 005 0
 973 008 006 0
 973 008 007 0

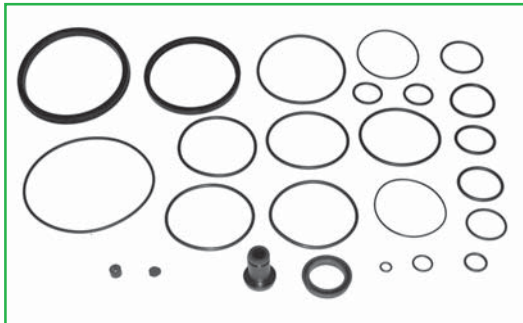

40.155.01.2

973 008 000 2

For:
 973 008 000 0

40.549 / 40.550

Trailer Control Valve Dorse Kontrol Valfi



973 002 402 0



973 002 520 0

IFN No	Ref No	Notes
40.549.402.0	973 002 402 0	SCANIA,IVECO.MERCEDES,DAF,VOLVO
40.549.000.0	973 002 000 0	SCANIA,IVECO.MERCEDES,DAF,VOLVO,MAN,RVI
40.550.520.0	973 002 520 0	MERCEDES,DAF

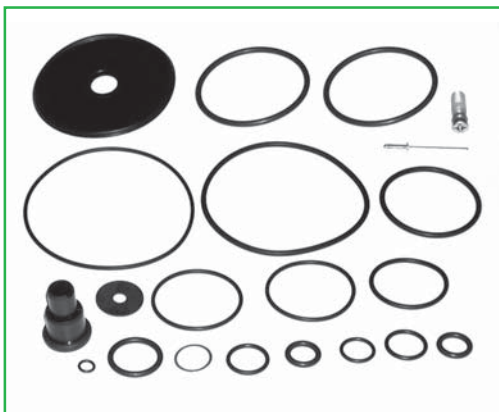

40.549.00.2

973 002 003 2

Replaces

- 40.549.01.2 973 002 004 2
- 40.549.02.2 973 003 000 2
- 40.549.09.2 973 002 009 2

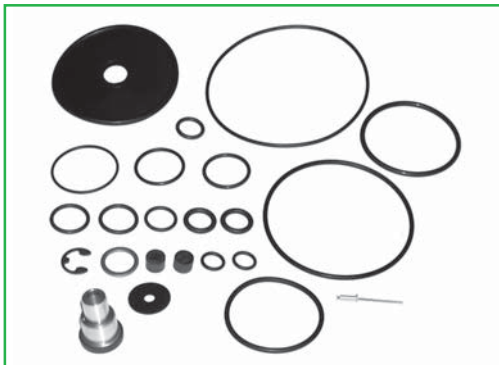

40.550.00.2

973 002 006 2

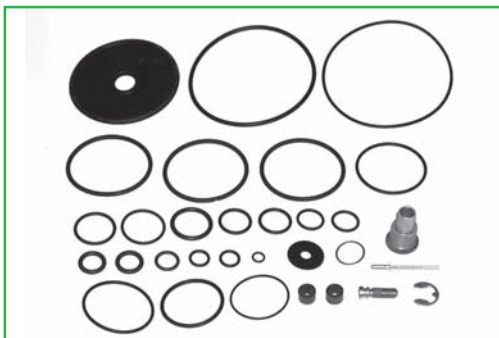

40.550.01.2

973 002 005 2

Replaces

- 40.550.00.2 973 002 006 2
- 40.550.02.2 973 003 008 2
- 40.549.00.2 973 002 003 2
- 40.549.01.2 973 002 004 2
- 40.549.02.2 973 003 000 2

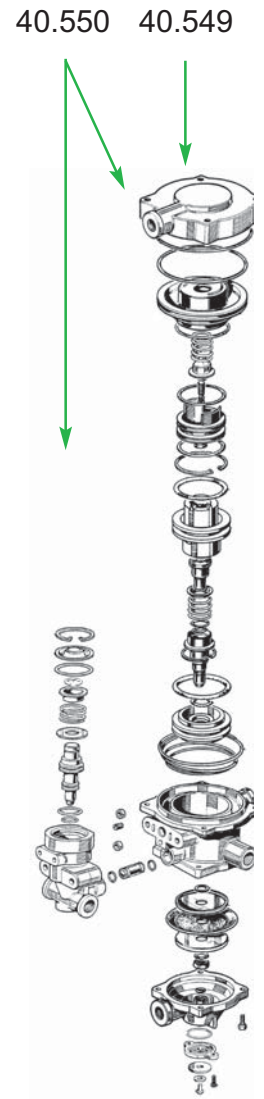

40.567 / 40.680

Trailer Control Valve
Dorse Kontrol Valfi



0 481 061 004



0 481 061 009

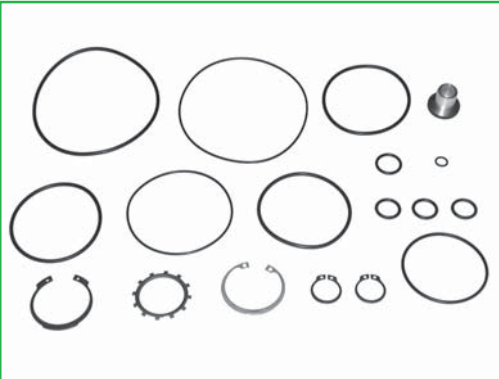

40.567.00.2

1 7706*

piston dia:16

Replaces
1 487 010 166
1 487 010 169

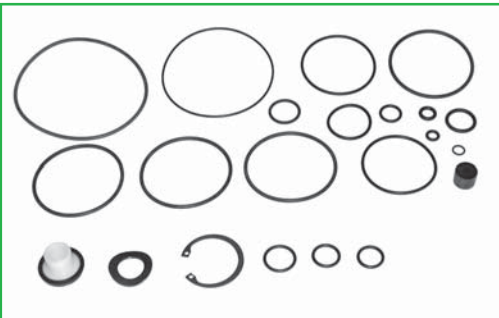

40.680.00.2

1 487 010 207

piston dia:18

Replaces
1 487 010 007

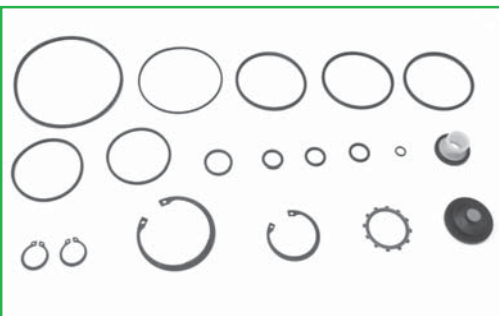

40.680.01.2

1 487 010 151

piston dia:20

Replaces
1 487 010 152

40.680.02.2

1 487 010 170

For
0 481 026 021

40.144

Trailer Control Valve
Dorse Kontrol Valfi

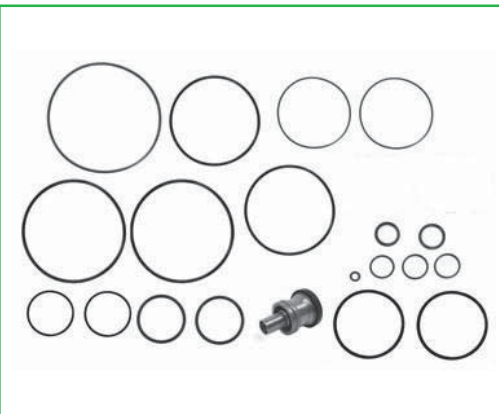

40.144.00.2

076615102000

For
AC 597A



40.586

Trailer Control Valve Dorse Kontrol Valfi



AB 2794

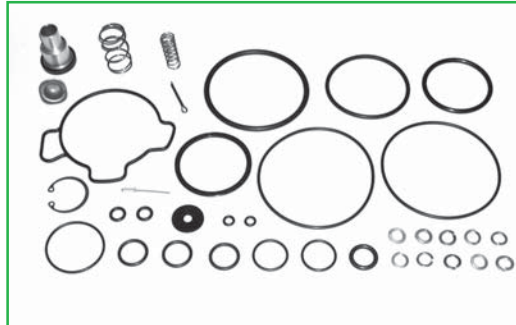

40.586.00.2

I 81985

For:
AB 2794
AB 2795

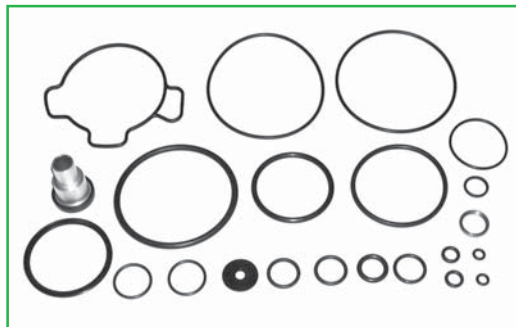

40.586.01.2

I 82919/0051

For:
AB 2793
Ab 2797
AB 2800

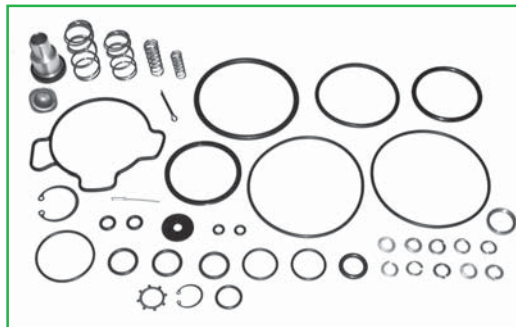

40.586.04.2

I 85063

For:
AB 2793
AB 2797
AB 2800

Replaces
I 89237
I 81611

40.574

Trailer Control Valve Dorse Kontrol Valfi



210 002 001

IFN No	Ref No	Notes	Details
40.574.00.0	201 002 001	MAN,MERCEDES,VOLVO,SCANIA,DAF	10 BAR,NPTF
40.574.01.0		MAN,MERCEDES,VOLVO,SCANIA,DAF	10 BAR Metric

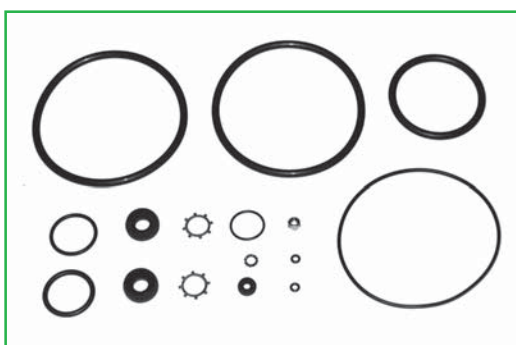

40.574.00.2

40.146

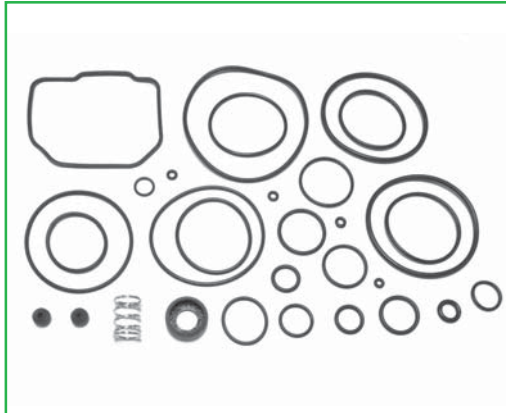
Trailer Control Valve
Dorse Kontrol Valfi
**40.146.00.2**

1 487 010 354

For
0 486 205 022

40.147

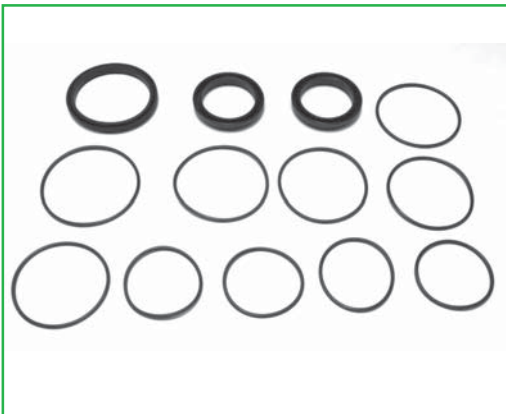
Park-release Emergency Valve
Acil Park Fren Valfi
**40.147.00.2**For
971 002 900 0

40.148

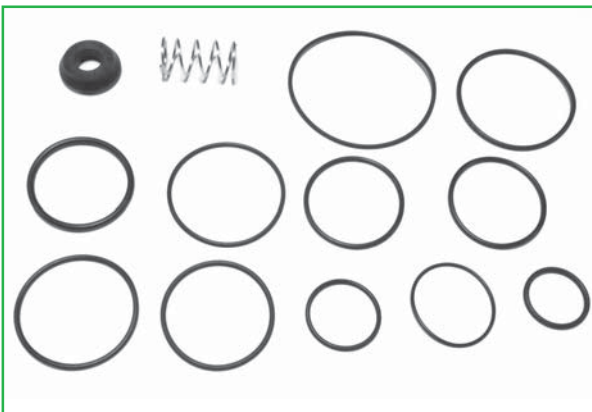
Trailer Control Valve
Dorse Kontrol Valfi
**40.148.00.2**For
K000917

40.149
Relay Valve
Röle Ventili

40.149.00.2

 For:
 973 006 000 0

 Little piston
 Küçük Sibop

40.149.01.2

 For:
 973 006 001 0

 Big piston
 Büyük Sibop

40.151
Proportional Valve
Prop Ventili

40.151.00.2

40.693

Relay Emergency Valve
Acil Röle Valfi

40.693.00.2

950 351 004

40.628

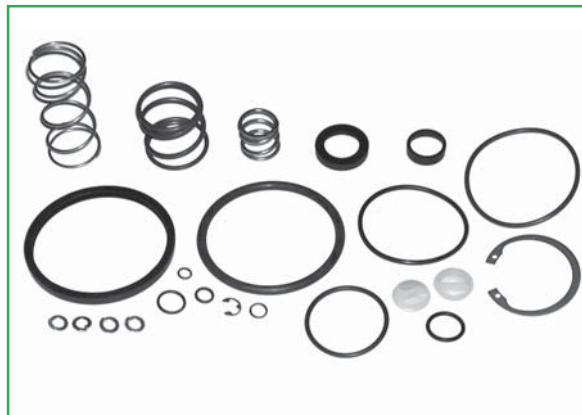
Trailer Control Valve
Dorse Kontrol Valfi

40.628.00.2

471 401 009 2

For:

471 401 000 0
 471 401 001 0
 471 401 010 0
 471 401 011 0

40.692

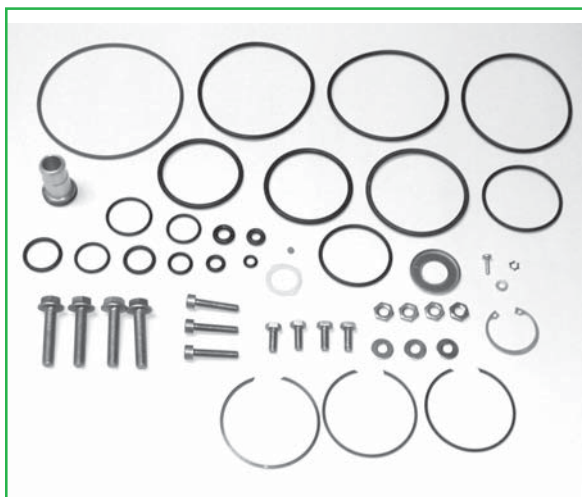
Trailer Control Valve
Dorse Kontrol Valfi

40.692.00.2

1 93362/008

45

RELAY VALVES

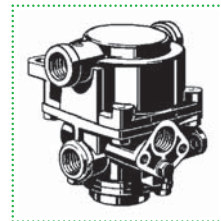
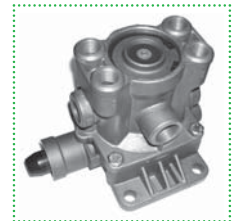
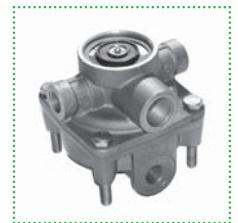

45.305 / 45.307

Relay Valve
Röle Valfi

R-6

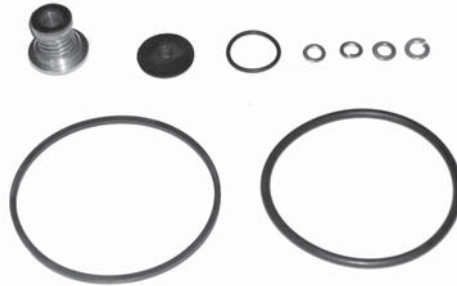

45.305.00.2

280856(SK2661.1)



RE-6

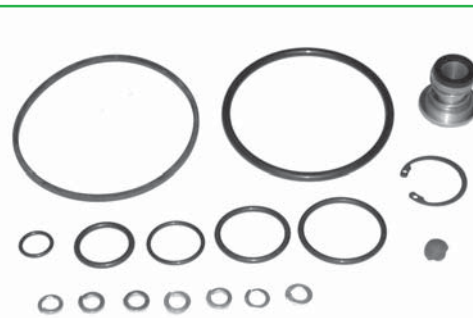

45.307.00.2

282812(SK2677.1)

45.471 / 45.593

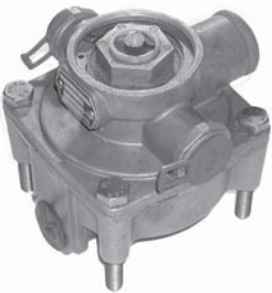
Relay Valve
Röle Valfi

RE 1105



45.471.00.2

I 82546

For:

RE 1105 RE 1125
 RE 1110 RE 1129
 RE 1111 RE 1132
 RE 1115 RE 1135
 RE 1117 RE 1138
 RE 1119
 RE 1122

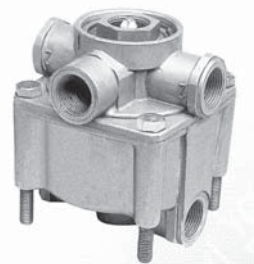

RE 2221



45.593.00.2

I 80221

For:

RE 2221 - I 63354

45.593.01.2

I 67698

For:

RE 2221 - I 61840

Only some o-ring sizes are different
 Sadece bazı o-ring ölçüleri farklıdır

45.715
Relay Valve
Röle Valfi

0 481 026 010



45.715.00.2

1 487 010 299

 For
 0 481 026 010
 0 481 026 014
 0 481 026 019
 0 481 026 021
 0 481 026 022

45.599
Relay Valve
Röle Valfi

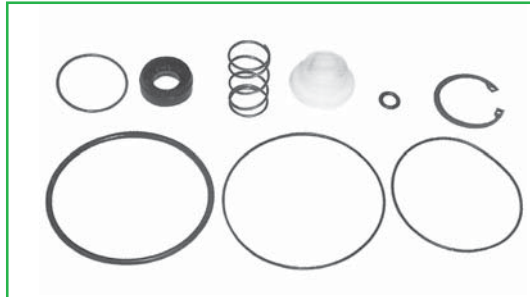
0 481 026 026

45.599.00.2

1 487 010 366

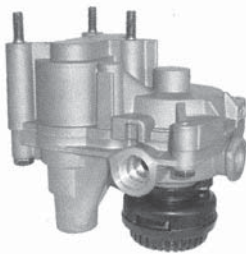
45.484
Proportional Relay Valve
Ayarlı Röle Valfi

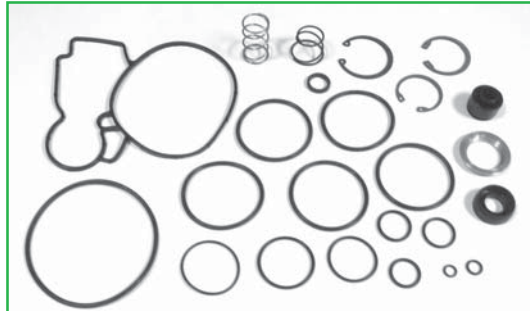
45.484.00.2

 For:
 480 202 004 0

45.484.01.2

 For:
 480 204 001 0

45.484.02.2

45.517

Relay Valve
Röle Valfi

İFN No	Ref No	Details	Notes
45.517.010.0	973 001 010 0	M22*1,5 / M22*1,5 / M22*1,5	MAN,MERCEDES,VOLVO,DEUTZ,DAF,IVECO,RVI
45.517.020.0	973 001 020 0	M22*1,5 / M16*1,5 / M16*1,5	MAN,MERCEDES,VOLVO,DAF,IVECO,RVI

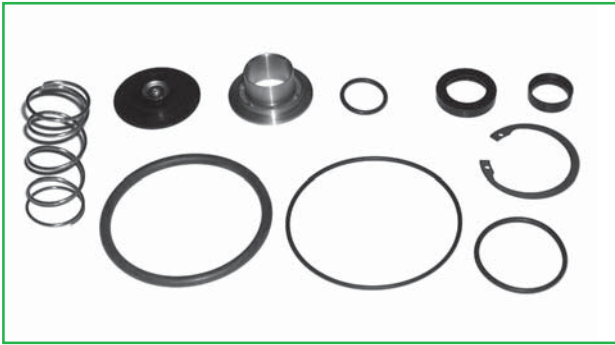

45.517.00.2

973 001 000 2



45.517.05.2

973 001 002 2



45.517.06.2

973 001 *** 2

Plastic Design

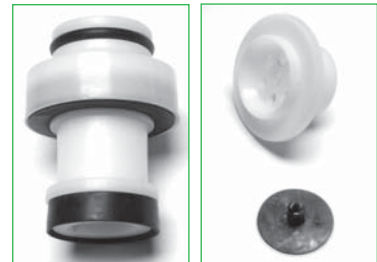

45.537
**Relay Valve
Röle Valfi**

473 017 *** 0

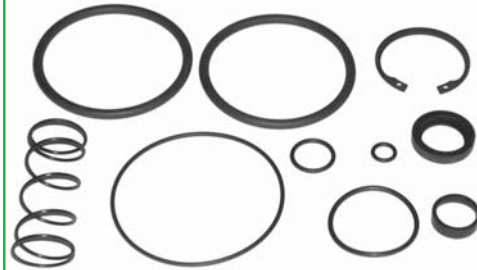
45.537.00.2

473 017 000 2

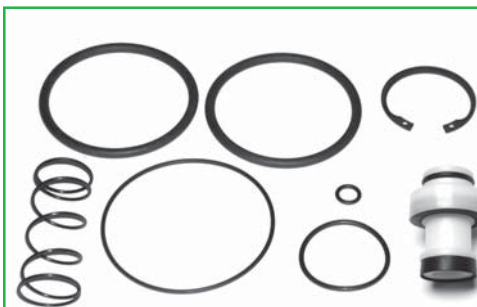
45.537.01.2

473 017 *** 2

45.646
**Relay Valve
Röle Valfi**

973 011 000 0

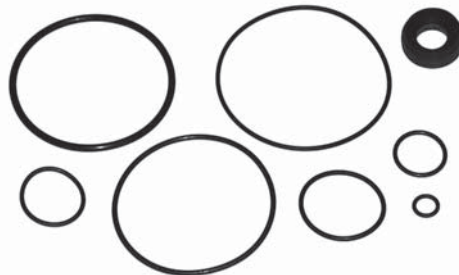
45.646.00.2

973 011 000 2

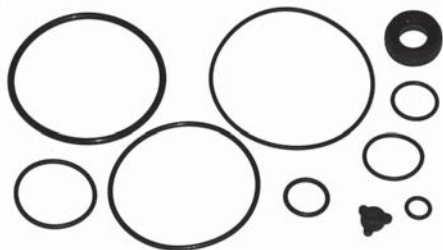
45.646.01.2

973 011 002 2

IFN No	Ref No	Details	Notes
45.646.000.0	973 011 000 0	M22*1,5 / M22*1,5 / M16*1,5	VOLVO,SCANIA,DAF,IVECO,RVI
45.646.001.0	973 011 001 0	M22*1,5 / M16*1,5 / M16*1,5	MAN,MERCEDES,BMC
45.646.011.0	973 011 011 0	M22*1,5 / M16*1,5 / M16*1,5	VOLVO

45.546

Relay Emergency Valve
Acil Röle Valfi

971 002 150 0



971 002 152 0

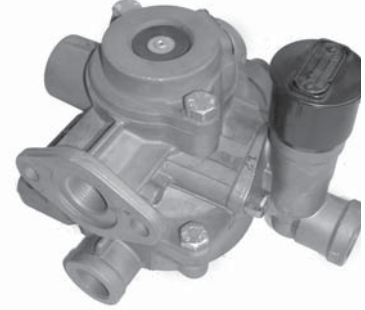

971 002 151 0

İFN No	Ref No	Notes
45.546.150.0	971 002 150 0	MAN,MERCEDES,DAF,VOLVO,SCANIA
45.546.152.0	971 002 152 0	DAF,NEOPLAN
45.546.151.0	971 002 151 0	MAN,MERCEDES,DAF,VOLVO,SCANIA

**45.546.00.2**

971 002 003 2

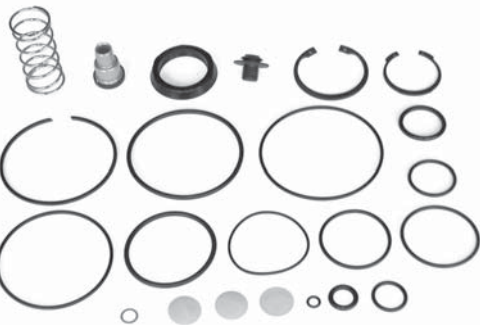
 For:
 971 002 150 0
 971 002 153 0
**45.546.01.2**

971 002 001 2

 For:
 971 002 110 0
**45.546.02.2**

971 002 004 2

 For:
 971 002 151 0
 971 002 152 0

55

CIRCUIT PROTECTION VALVES

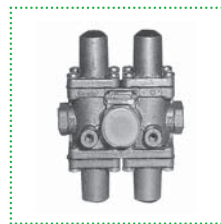
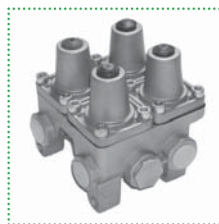
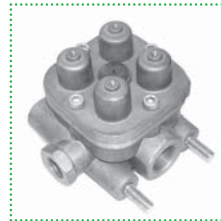
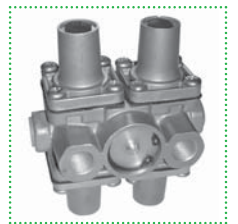

55.203

Circuit Protection Valve
Dörtlü Dağıtıcı Valf

934 713 004 0

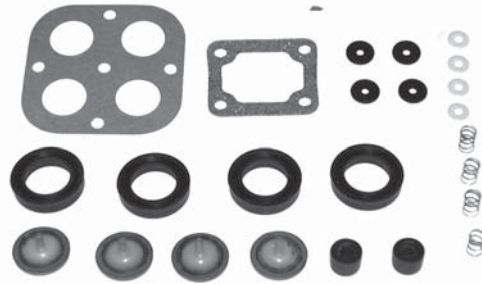

55.203.00.2

934 713 *** 2



55.203.01.2

934 714 *** 2

55.532

Protection Valve
Dağıtıcı Valf

0 481 027 104

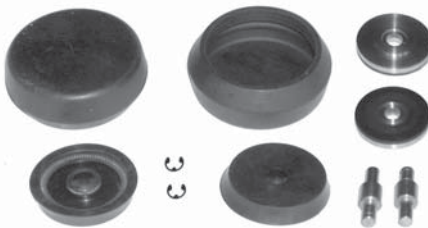

55.532.00.2

1 487 *10 245



55.532.01.2

1 487 010 245

55.540

Circuit Protection Valve Dörtlü Dağıtıcı Valf



AE 4603



AE 4609



AE 4610



AE 4613

İFN No	Ref No	Notes	Description
55.540.03.0	AE 4603	VOLVO	M22*1,5 M16*1,5
55.540.09.0	AE 4609	MAN-BMC	M22*1,5 VOSS
55.540.10.0	AE 4610	DAF-LEYLAND	M22*1,5 M16*1,5
55.540.13.0	AE 4613	MAN	M22*1,5 M16*1,5

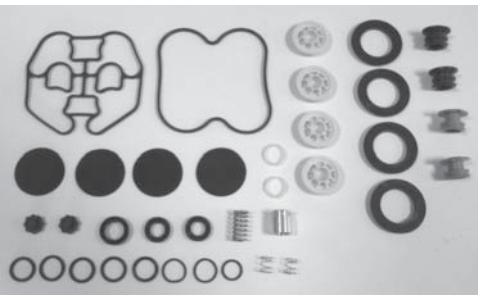

55.540.00.2

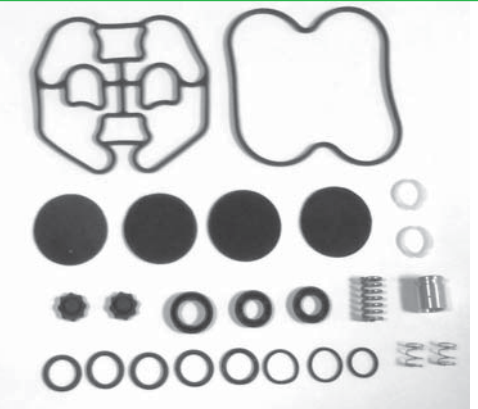

55.540.01.2



27-3125

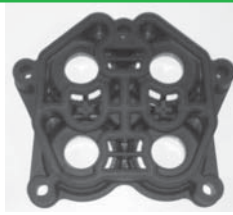

27-3126

55.538

Circuit Protection Valve
Dörtlü Dağıtıcı Valf

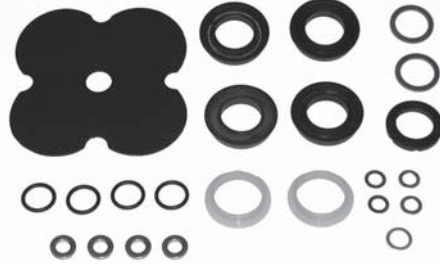

İFN No	Ref No	Notes
55.538.58.0	AE 4158	MAN, MERCEDES, SCANIA, RVI, IVECO
55.538.62.0	AE 4162	MAN, MERCEDES, SCANIA
55.538.70.0	AE 4170	MERCEDES, DAF, IVECO

**55.538.00.2**

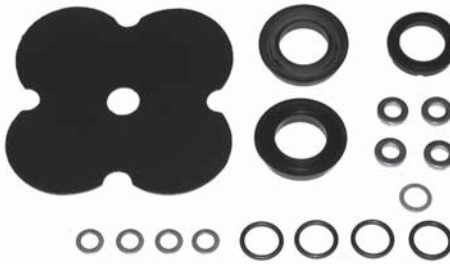
I 81171

**55.538.01.2**

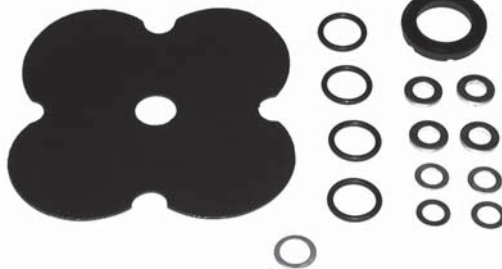
I 78183

**55.538.04.2**

I 80448

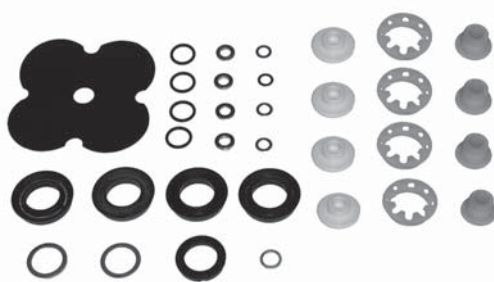
**55.538.05.2**

I 8117*

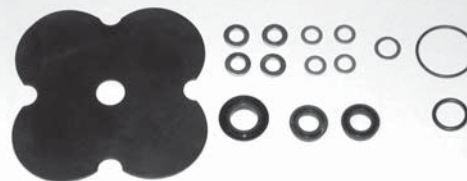
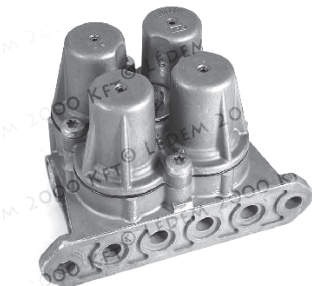
**55.538.08.2**

II 17189 / 008

55.539

Circuit Protection Valve Dörtlü Dağıtıcı Valf



0 481 062 101



55.539.00.2 1 487 010 ***

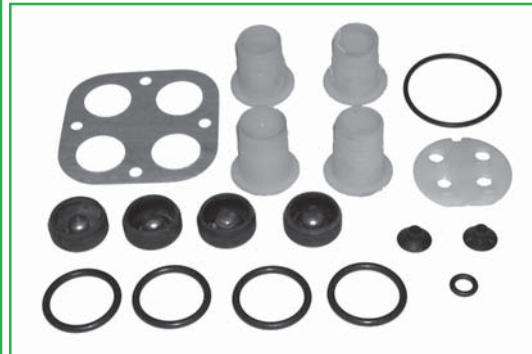

55.539.01.2 1 487 010 ***

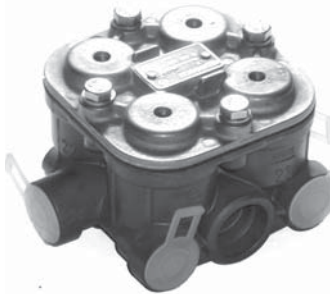

0 481 062 201



55.539.02.2 1 487 010 234

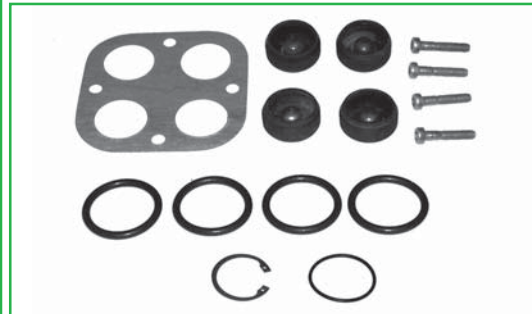

55.539.03.2 1 487 010 237

55.572

Circuit Protection Valve Dörtlü Dağıtıcı Valf

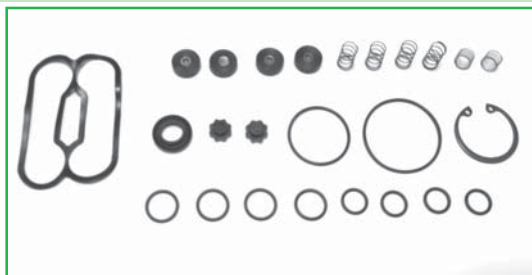
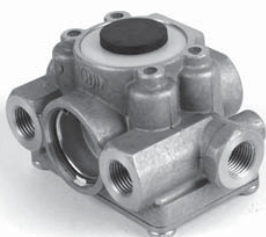

55.572.00.2 076637201000

For
VPS45A

55.568 / 569

Circuit Protection Valve
Dörtlü Dağıtıcı Valf

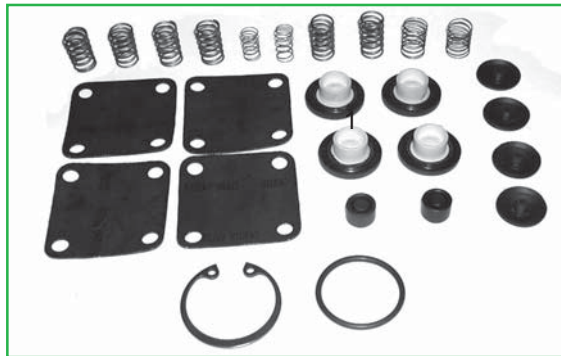
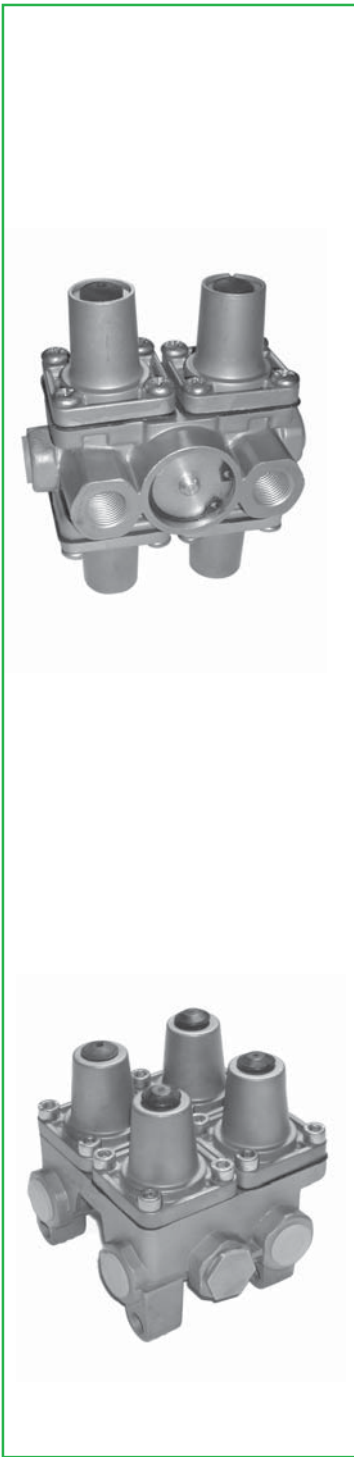

55.568.03.2 934 702 000 2

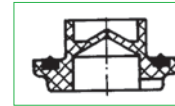

1

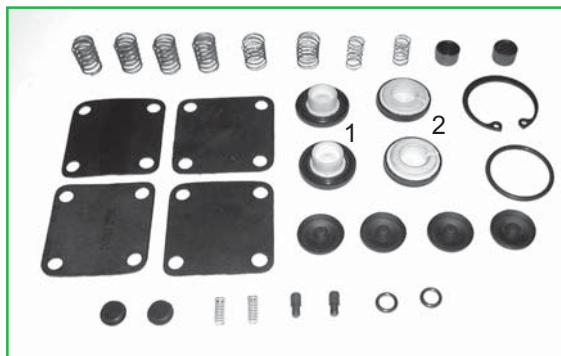

55.568.09.2 934 901 002 2

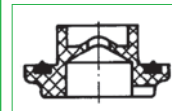

1

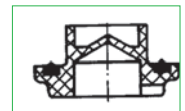

2

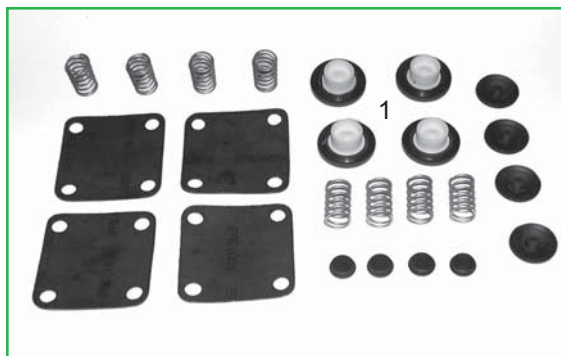

55.568.06.2 934 702 006 2

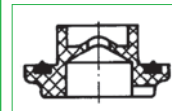

1

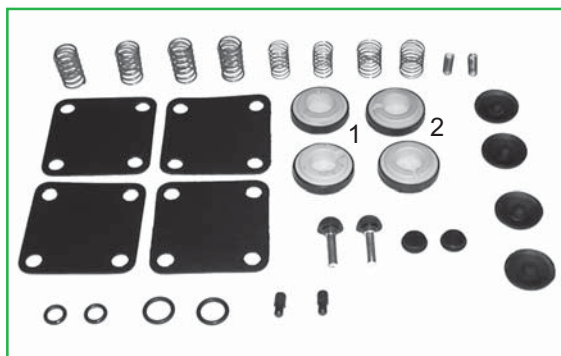

55.569.00.2 934 702 005 2

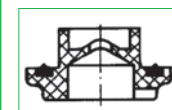

1

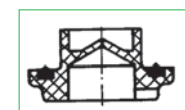

2

60

SPRING BRAKES

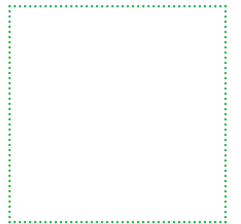
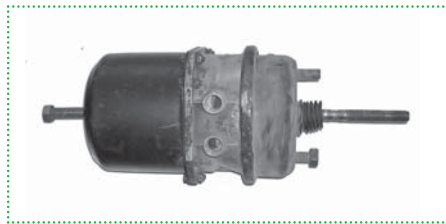

60.554

Spring Brakes
Fren Körüğü

60.554.03.2

Type 24

60.554.04.2

Type 30

60.554.05.2

Type 16

60.554.06.2

Type 20

60.554.07.2

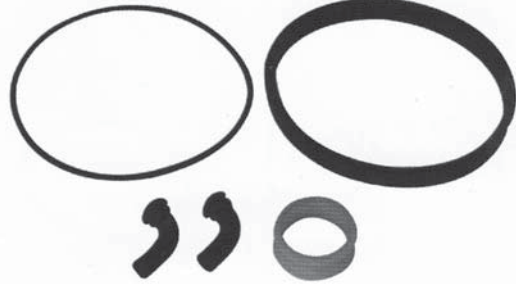
925 439 100 0
Ø27 x 24

Caps

One Hole
60.588.00.1Two Holes
60.588.01.1Mgm Type
60.588.02.1

60.580.01.1 Ø 115
60.580.02.1 Ø 125-thin
60.580.03.1 Ø 125-thick
60.580.04.1 Ø 150
60.580.05.1 Ø 170 thin
60.580.06.1 Ø 170 thick



60.460.00.1

One Lip(Tek Dudak)

60.460.01.1

Two Lips (Çift Dudak)

60.650

 Diaphragms
Diyaframlar

Standart

60.650.01.1	Ø 36
60.650.02.1	Ø 30
60.650.03.1	Ø 27
60.650.04.1	Ø 24
60.650.05.1	Ø 20
60.650.06.1	Ø 16
60.650.07.1	Ø 14
60.650.08.1	Ø 12
60.650.09.1	Ø 9
60.650.10.1	Ø 3

Long Stroke

60.651.01.1	Ø 30
60.651.02.1	Ø 24
60.651.03.1	Ø 20
60.651.04.1	Ø 16
60.651.05.1	Ø 14
60.651.06.1	Ø 12
60.651.07.1	Ø 9

60.565

Spring Brakes
Fren Körüğü

İFN No	Ref No	Notes	Description
60.565.00.0	BZ 6517	115/150	MAN
60.565.01.0	BZ 6621	125/150	MAN, RVI

**60.565.00.2**

/ 67587

Type 125 / Big Type

**60.565.01.2**

/ 69698

Type 115 / Small Type

60.403

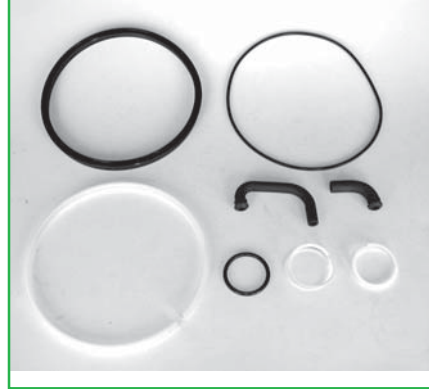
 Spring Brakes
Fren Körüğü

60.403.00.2

Type 27
Mostly For Mercedes 403 Bus
Çoğunlukla Mercedes 403 Otobüs
için

60.404 / 60.578

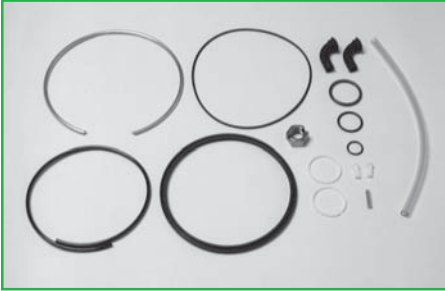
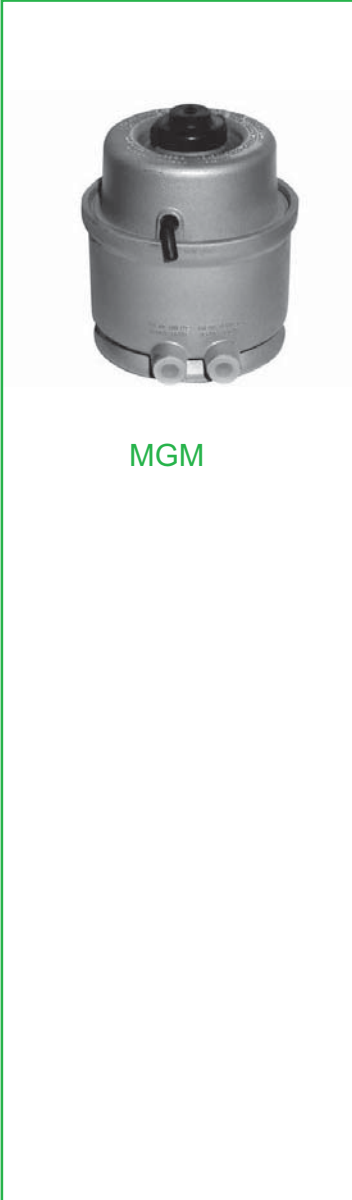
 Spring Brakes
Fren Körüğü

60.404.00.2

SK 3054 / 24

Type 24 - Bendix Type

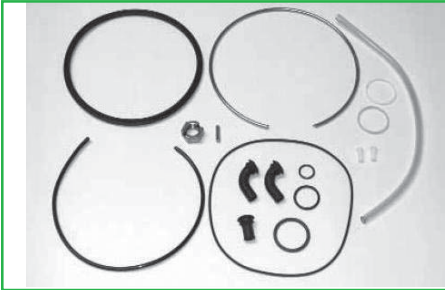

60.404.01.2

SK 3054 / 30

Type 30 - Bendix Type



60.404.02.2

9040015

Type 30 - Bendix Type



60.578.00.2

890 110 108 2

Type 30 - Mgm Type Old

60.578.01.2

890 110 107 2

Type 24 - Mgm Type Old

70

LEVELLING VALVES

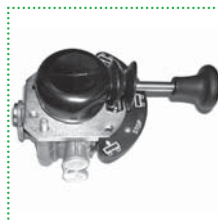
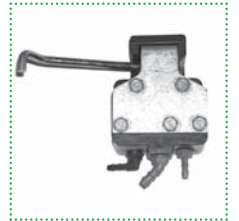

70.105

 Suspansion Valve
 Süspansiyon Körük Ventili

İFN No	Ref No	Notes
70.105.000.0	464 006 000 0	VOLVO-DAF
70.105.001.0	464 006 001 0	IVECO
70.105.002.0	464 006 002 0	MAN-MERCEDES-VOLVO
70.105.100.0	464 006 100 0	MERCEDES

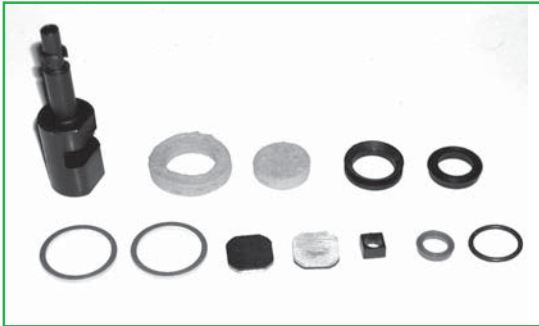

70.105.00.2

464 006 000 2

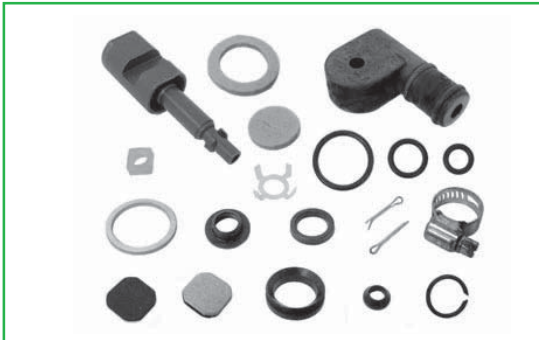

70.105.01.2

464 006 001 2

70.107

 Suspansion Valve
 Süspansiyon Körük Ventili

70.107.00.2

70.115

Suspension Valve
Süspansiyon Körük Ventili

İFN No	Ref No	Notes
70.115.330.0	464 002 330 0	MAN-MERCEDES-VOLVO-DAF-SCANIA-IVECO-BPW-RVI-BMC

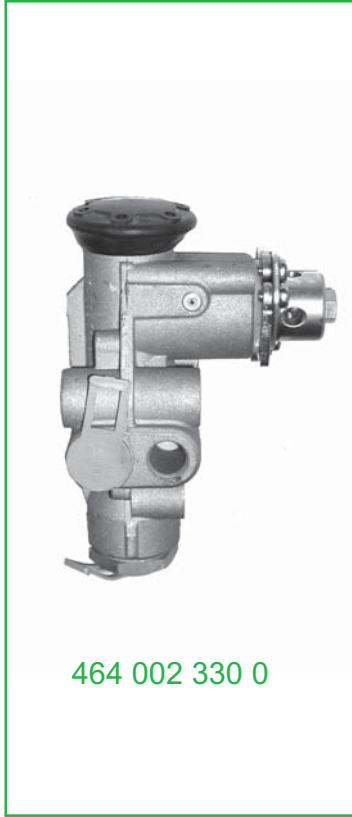

70.115.00.2 464 002 005 2

70.115.01.2 464 002 008 2

70.116

Cabin Levelling Valve
Kabin Körük Ventili

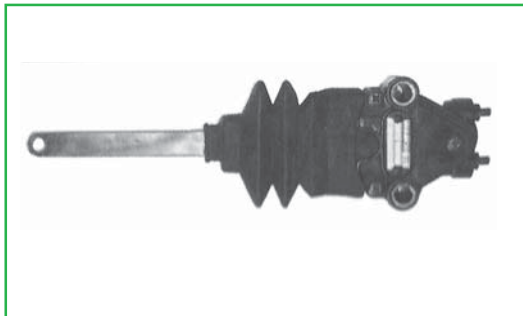
İFN No	Ref. No	Details	Notes
70.116.001.0	464 007 001 0	Plastic	SCANIA-IVECO-RVI-DAF-MAN
70.116.009.0	464 007 009 0	Plastic	SCANIA-IVECO-RVI-DAF-MAN
70.116.011.0	464 007 011 0	Plastic	MERCEDES
70.116.010.0	464 007 010 0	Plastic	SCANIA-DAF-RVI
70.116.002.0	464 007 002 0	Aluminium	DAF-RVI-VOLVO
70.116.007.0	464 007 007 0	Aluminium	RVI

70.116.00.2

70.723

 Suspension Valve
 Süspansiyon Körük Ventili

1



SV 1294

2

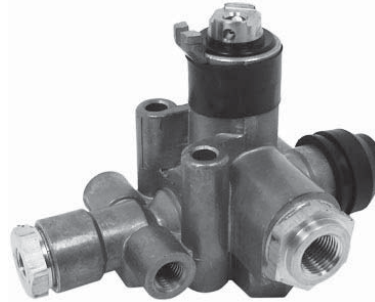

SV 1280

3



SV 1295

IFN No	Ref. No	Fig.	Details	Notes
70.723.294.0	SV 1294	1	Without Lever	MAN-VOLVO-SCANIA
70.723.260.0	SV 1260	1	Lever 210 mm	IVECO
70.723.307.0	SV 1307	1	Rod:Ø6*300 mm/10 bar	IVECO
70.723.395.0	SV 1395	1	Rod:Ø6*300 mm/12,5 bar	MAN
70.723.412.0	SV 1412	1	Without Rod	VOLVO
70.723.288.0	SV 1288	1	Without Lever	MAN
70.723.345.0	SV 1345	1	Without Lever	MAN
70.723.411.0	SV 1411	1	Without Rod	MAN
70.723.280.0	SV 1280	2	Air Signal Port Closed	MERCEDES-RENAULT-DAF
70.723.281.0	SV 1281	2	Air Signal Port Open	MERCEDES
70.723.295.0	SV 1295	3	Without Lever	VOLVO-SCANIA-MAN
70.723.399.0	SV 1399	3	Without Lever	VOLVO

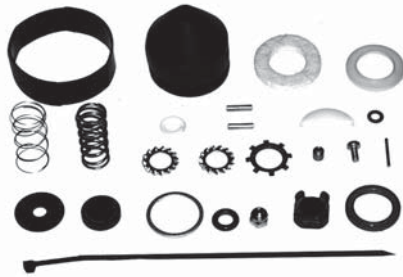

70.723.00.2

/ 69784

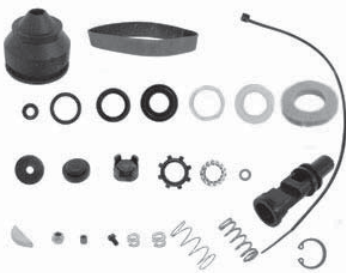

70.723.01.2

/ 86534

70.591

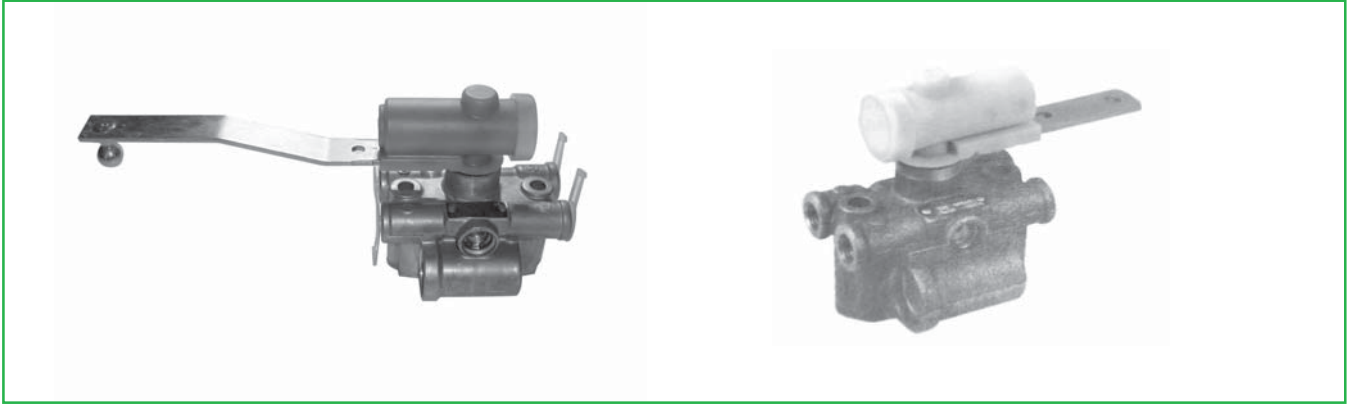
Suspansion Valve
Süspansiyon Körük Ventili

İFN No	Ref. No	Details	Notes
70.591.001.0	0 500 005 001	Long / Right	SCANIA
70.591.002.0	0 500 005 002	Long / Left	SCANIA
70.591.006.0	0 500 005 006	Short / Right	VOLVO-DAF
70.591.007.0	0 500 005 007	Short / Left	VOLVO-DAF
70.591.101.0	0 500 005 101	Long / Right	MERCEDES
70.591.102.0	0 500 005 102	Long / Left	MERCEDES
70.591.104.0	0 500 005 104	Short / Right	MERCEDES
70.591.105.0	0 500 005 105	Short / Left	MERCEDES



70.591.01.2

1 507 010 007



70.591.02.2

1 507 010 ***

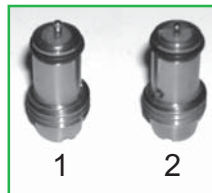

70.591.00.2

1 507 010 ***

- 1 70.591.50.1 Hard(Sert)
 2 70.591.60.1 Soft(Yumuşak)

70.725

 Suspension Valve
 Süspansiyon Körük Ventili

SV 3111

İFN No	Ref. No	Notes
70.725.111.0	SV 3111	MERCEDES-VOLVO
70.725.115.0	SV 3115	MERCEDES-RVI

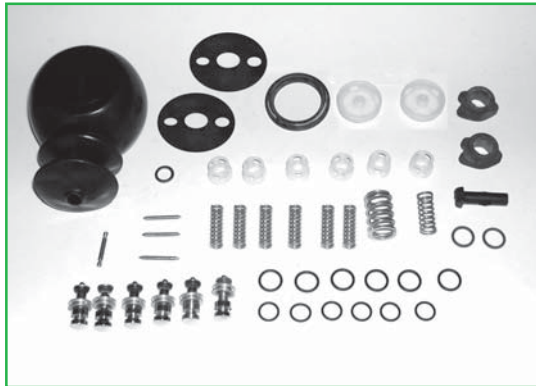

70.725.00.2 1 87465

70.725.01.2 1 8746*

 Pistonsuz Takım
 Kit Without Pistons

70.104

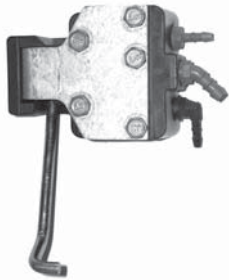
 Suspension Valve
 Süspansiyon Körük Ventili

464 005 000 0

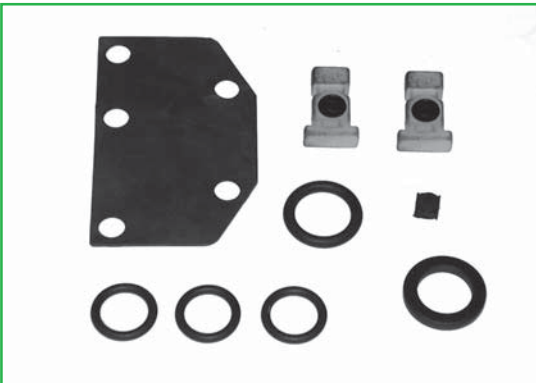

70.104.00.2 464 005 000 2

70.678

 Rotary Slide Valve
 Körük İndirme Kaldırma Valfi

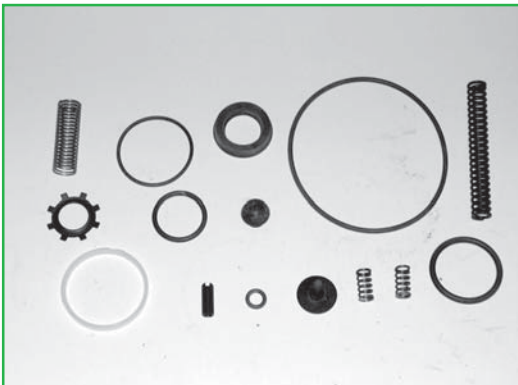

463 032 *** 0



70.678.00.2 463 032 000 2

75

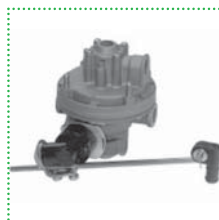
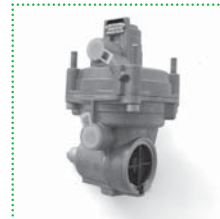
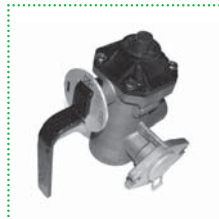
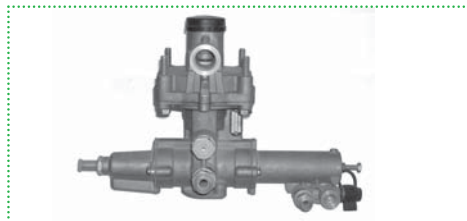
LOAD SENSING VALVES



75.150

Load Sensing Valve Yük Ayar Ventili

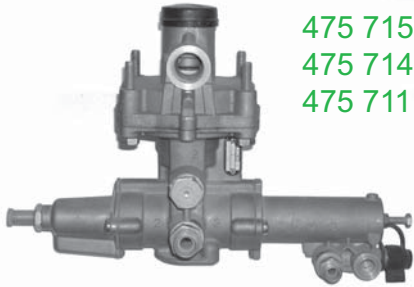

475 715 500 0
475 714 500 0
475 711 076 0

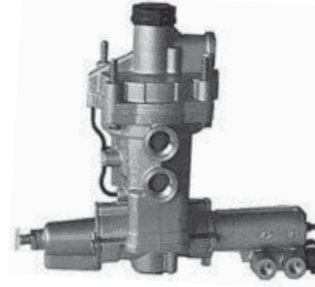

475 715 000 0
475 715 001 0
475 715 002 0

IFN No	Ref. No	Notes
75.150.500.0	475 715 500 0	MERCEDES-VOLVO-SCANIA
75.150.176.0	475 711 076 0	MERCEDES
75.150.450.0	475 714 500 0	MERCEDES-DAF-NEOPLAN



75.150.00.2

475 715 000 2

475 715 000 0 475 715 501 0
475 715 001 0 475 715 502 0
475 715 002 0 475 715 507 0
475 715 003 0 475 715 511 0

95-1404
plastic piston



SPN 3A

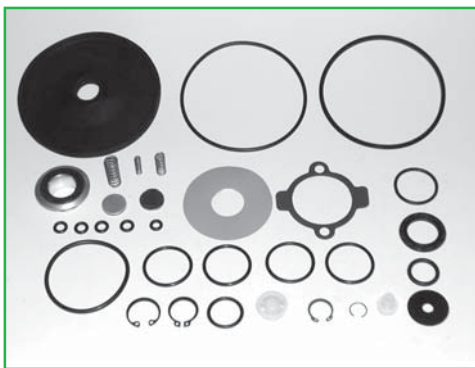
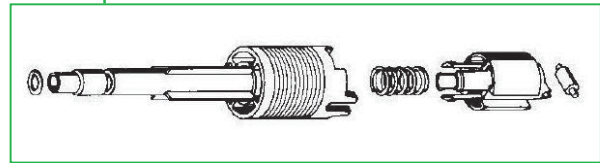

75.150.01.2

475 711 000 2

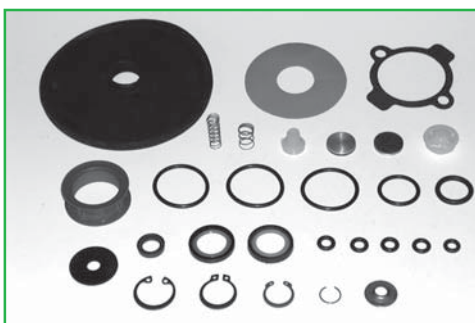

75.150.02.2

475 711 001 2

75.609

Load Sensing Valve
Yük Ayar Ventili

475 710 020 0



475 712 000 0



475 713 000 0



475 710 136 0

IFN No	Ref. No	Notes
75.609.020.0	475 710 020 0	MERCEDES-VOLVO-DAF-MAN-IVECO-RVI
75.609.712.0	475 712 000 0	DAF
75.609.713.0	475 713 000 0	IVECO-DAF
75.609.136 0	475 710 136 0	MERCEDES-DAF



75.609.00.2

475 710 001 2

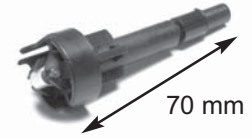

SPN 3

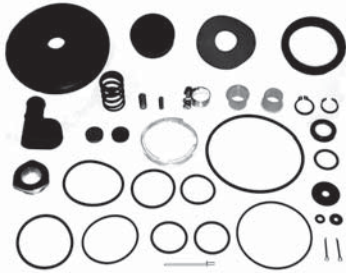

75.609.04.2

475 712 000 2

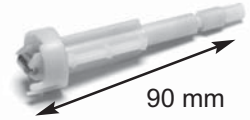

SPN 102

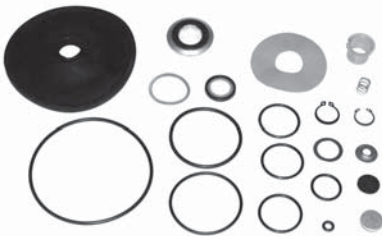

75.609.03.2

475 710 002 2



95-0646-B

Triangle Aluminium Piston

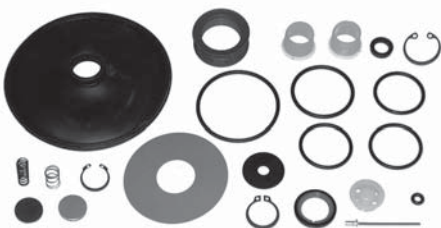

75.609.05.2

475 713 000 2

75.612

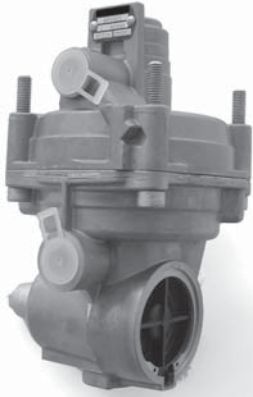
 Load Sensing Valve
Yük Ayar Ventili

BR 4412

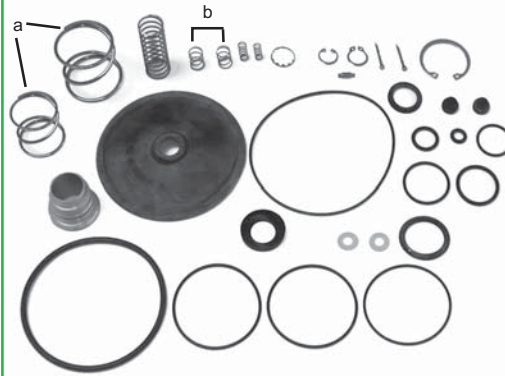

75.612.00.2 I 84451 / 008
I 87895
I 90900
I 93567 / 008
I 87354 / 008

a Ø 41 I 84451 / 008
I 90900
I 87354 / 008
Ø 36 I 87895
I 93567 / 008



b Ø 5,8 I 84451 / 008
I 90900
I 87895
I 87354 / 008
Ø 4,8 I 93567 / 008

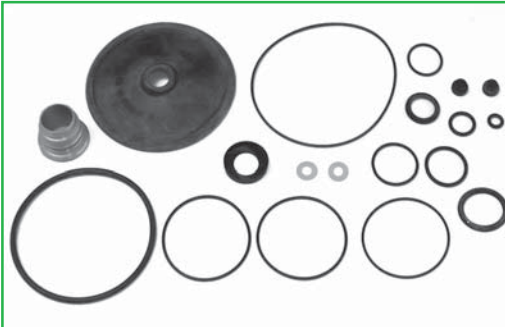
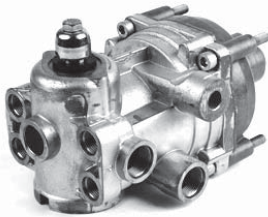

75.612.01.2 I 81595 / 0051

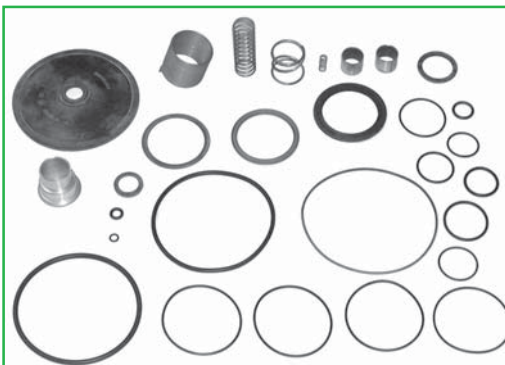

75.612.03.2 SEB 22187

For
BR 4351
BR 4352
BR 4355



75.724

Manuel Empty-Load Valve
Manuel Yük Ayar Valfi

464 604 010 0



75.724.00.2 475 604 002 2

75.607

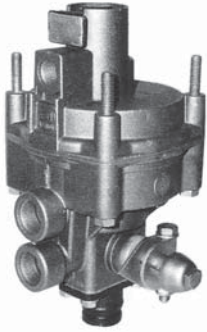
Load Sensing Valve
Yük Ayar Ventili

0 481 036 1**

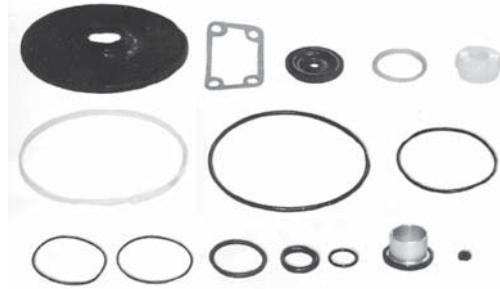

75.607.00.2 1 487 010 098

75.610

Load Sensing Valve
Yük Ayar Ventili

475 700 403 0



75.610.00.2

475 700 003 2

75.606

Load Sensing Valve
Yük Ayar Ventili

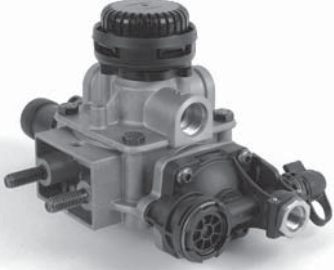

475 721 009 0

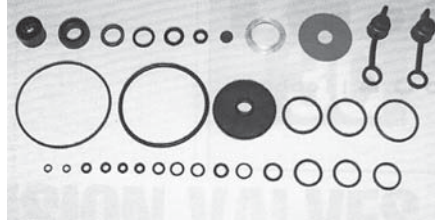

75.606.00.2

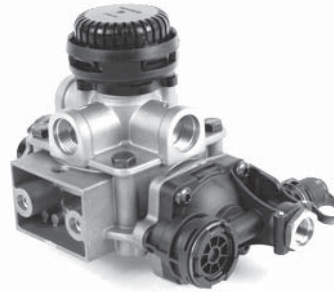

475 720 004 0

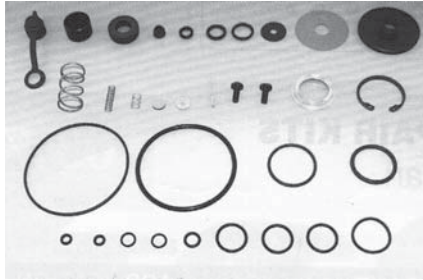

75.606.01.2

80

AIR DRYERS

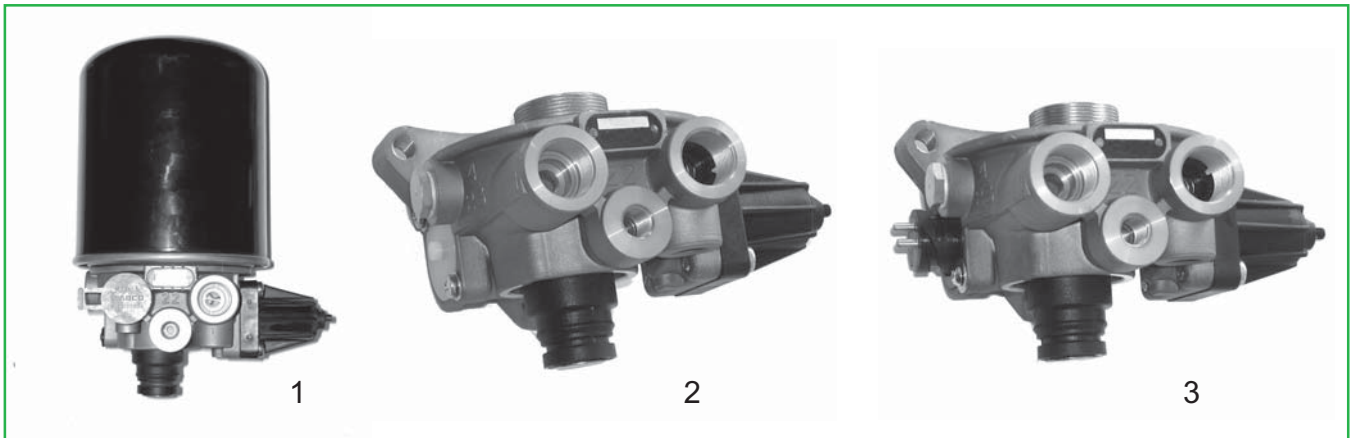

80.658
**Air Dryer Valve
Kurutucu Valfi**

IFN No	Ref. No	Fig.	Cut-Out Pressure	Notes
80.658.000.0	432 410 000 0	3	8,1 bar	Steyr
80.658.007.0	432 410 007 0	3	8,5 bar	Mercedes
80.658.008.0	432 410 008 0	3	11,8 bar	Evobus
80.658.023.0	432 410 023 0	2	11,0 bar	iveco Eurocargo,Eurotracker,Eurotech,Eurostar
80.658.031.0	432 410 031 0	2	7,8 bar	Iveco MK
80.658.041.0	432 410 041 0	3	8,5 bar	Mercedes 0303 Bus
80.658.043.0	432 410 043 0	3	9,5 Bar	Mercedes
80.658.067.0	432 410 067 0	3	8,5 bar	Mercedes
80.658.087.0	432 410 087 0	3	12 bar	Volvo, Daf
80.658.111.0	432 410 111 0	2	12,5 bar	Man F2000, M2000
80.658.117.0	432 410 117 0	2	10,0 bar	Man F2000, M2000
80.658.210.0	432 421 000 0	-	Max 13 bar	Mercedes 0405 Bus
80.658.212.0	432 421 002 0	-	Max 13 bar	Mercedes 1935 4*2
80.658.217.0	432 421 007 0	-	Max 13 bar	Mercedes SK 2448, SK 2550
80.658.218.0	432 421 008 0	-	Max 13 bar	Mercedes

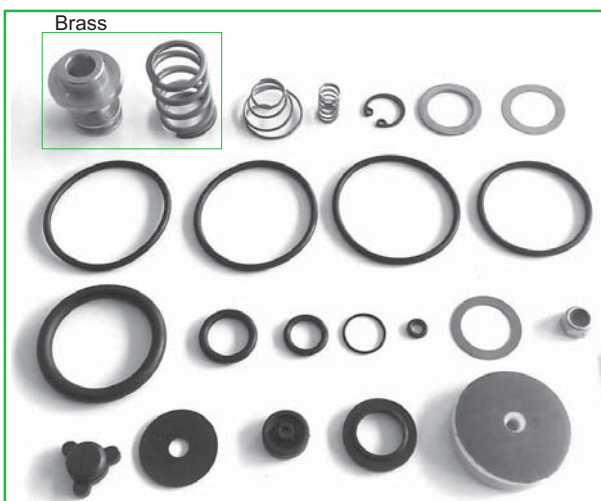
80.658.04.2

432 410 0** 2



80.658.05.2

80.658

Air Dryer Valve
Kurutucu Valfi

80.657.00.2

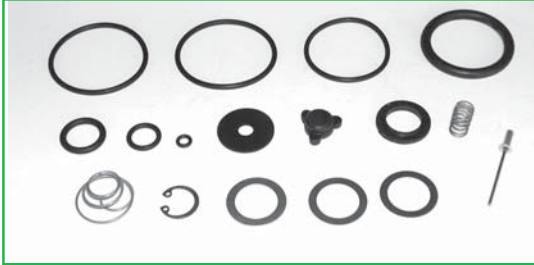
432 410 001 2



80.658.00.2

432 410 000 2



80.658.01.2

432 410 002 2

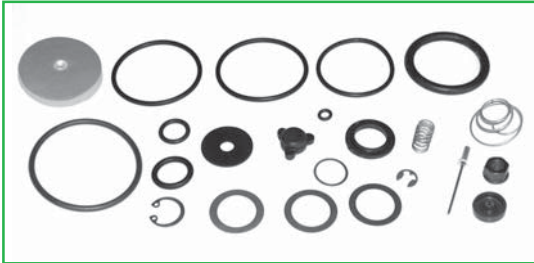

80.658.02.2

432 410 0** 2



80.658.03.2

432 415 000 2



80.658.08.2

432 425 92* 2

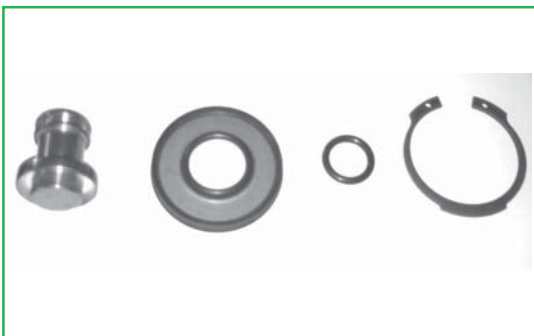

80.658.07.2

432 425 922 2

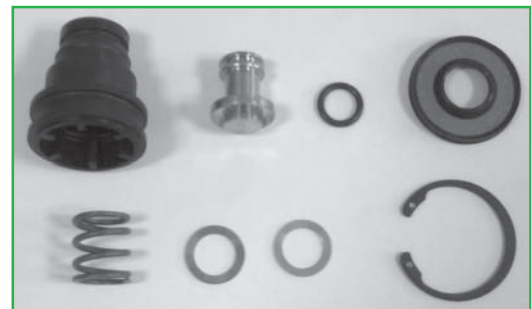

80.658.09.2

932 510 953 2

80.658

Air Dryer Valve
Kurutucu Valfi

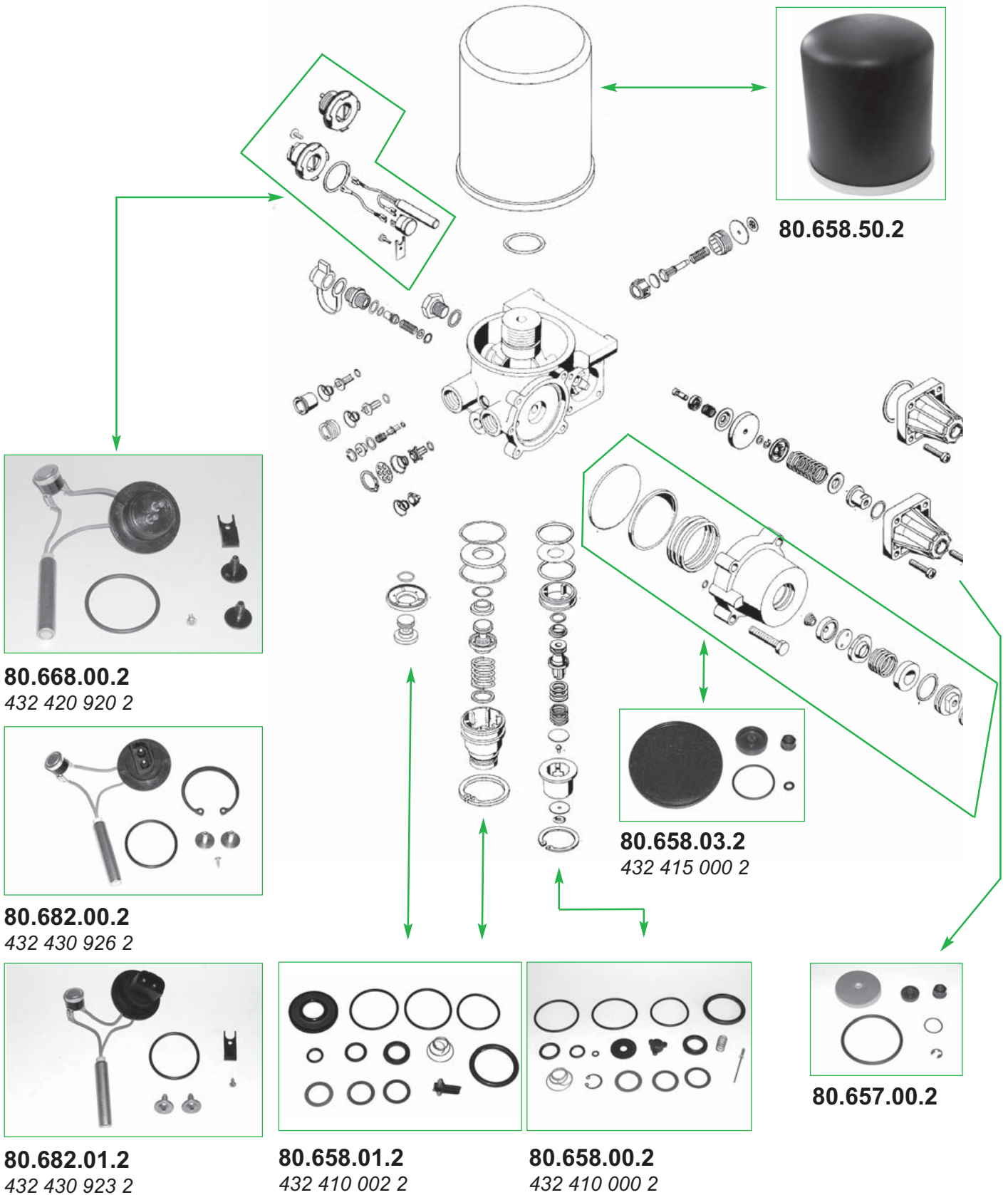

80.659

Air Dryer Valve
Kurutucu Valfi

IFN No	Ref. No	Unloader	Heater	Pressure
80.659.08.0	LA 8208	with	24 V	8,5
80.659.09.0	LA 8209	with	---	10,0
80.659.10.0	LA 8210	with	24 V	10,0
80.659.11.0	LA 8211	with	---	12,5
80.659.12.0	LA 8212	with	24 V	12,5
80.659.25.0	LA 8225	with	24 V	8,1



80.659.00.2

I 90121

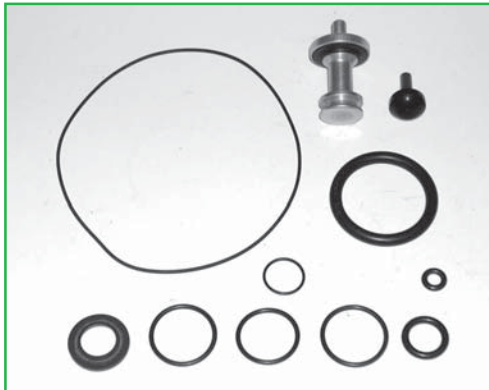

80.659.01.2

I 85139 / 0051

80.659

Air Dryer Valve
Kurutucu Valfi

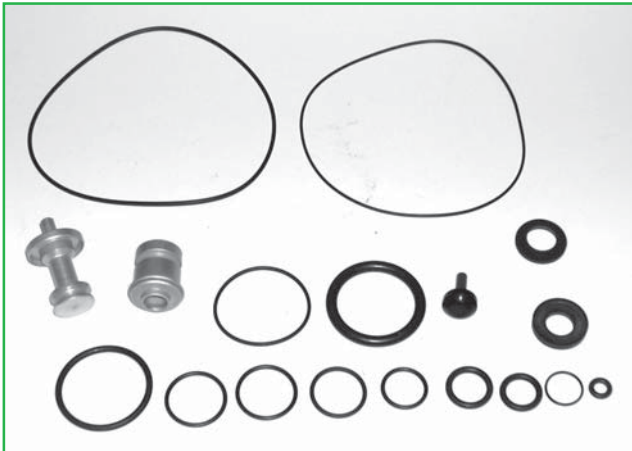

80.659.02.2

1 85133 / 0051



80.659.03.2

1 87917

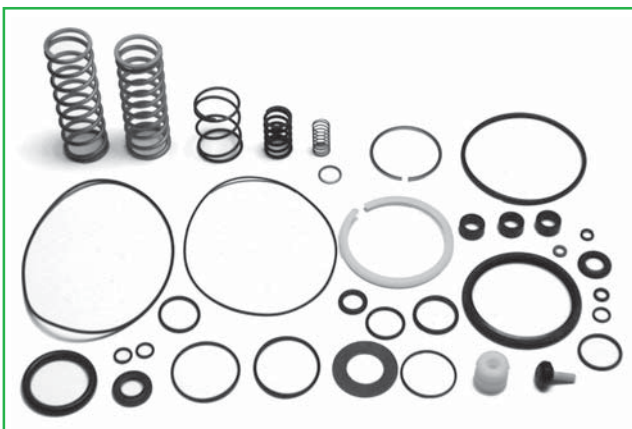

80.659.05.2

1 36245 / 008



80.659.60.4 Plastik Cover



80.660.00.2 1 87122 / 004



80.659.80.4 Al.Piston

80.683

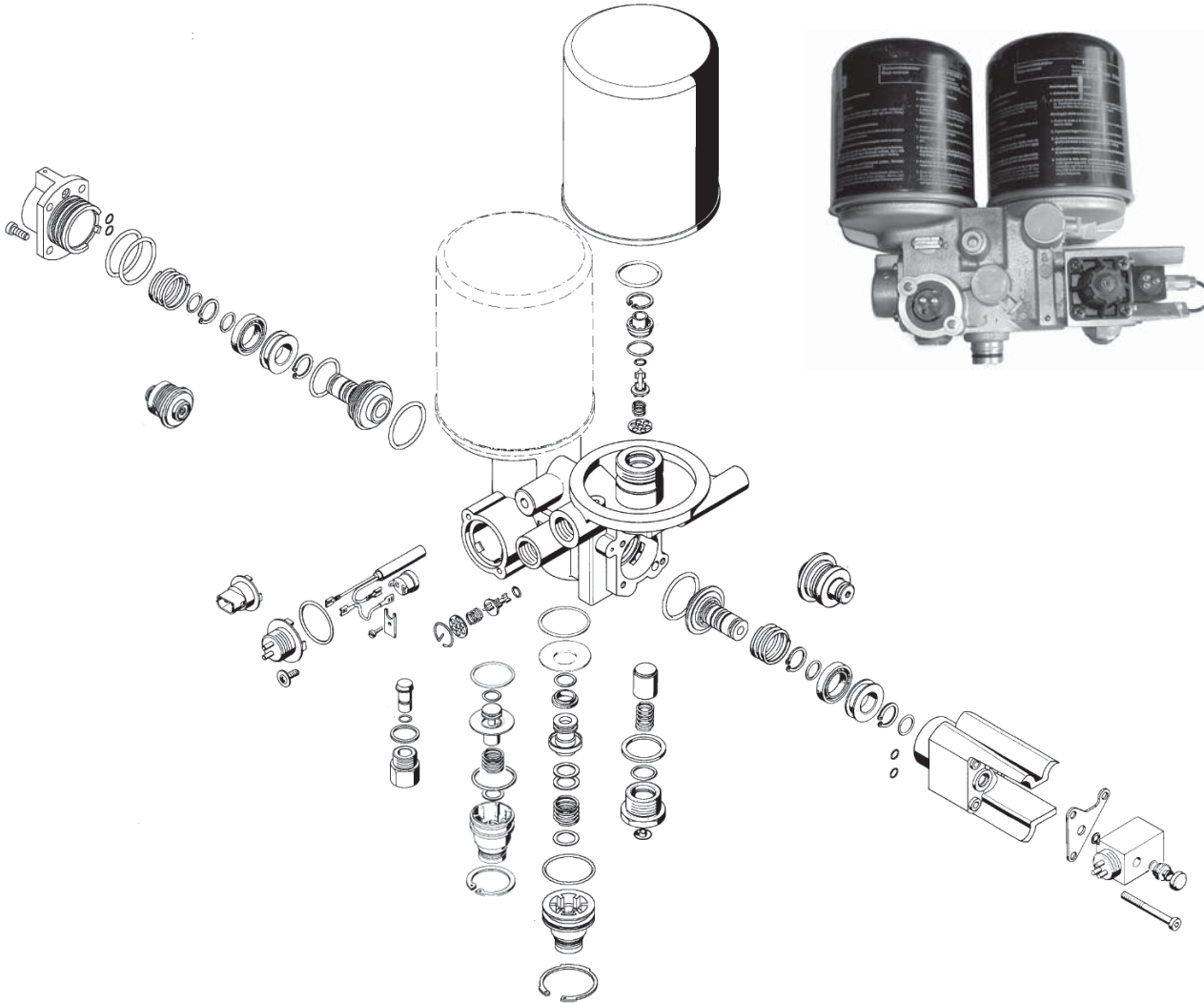
Double Cannister Air Dryer Valve
Çiftli Kurutucu Valfi**80.683.00.2**

432 431 000 2

80.683

Double Cannister Air Dryer Valve
Çiftli Kurutucu Valfi



80.683.01.2

432 431 001 2



80.683.02.2

432 431 002 2



80.681.00.2

432 431 923 2



80.681.01.2

432 431 930 2

80.558

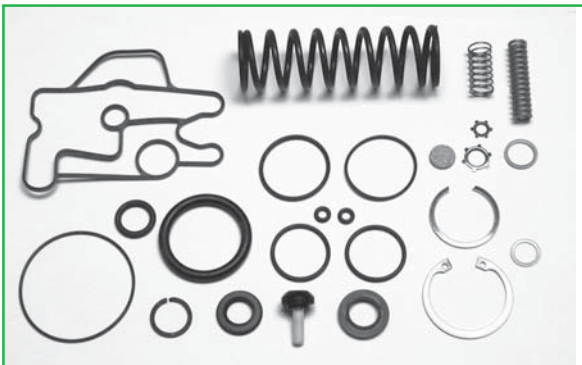
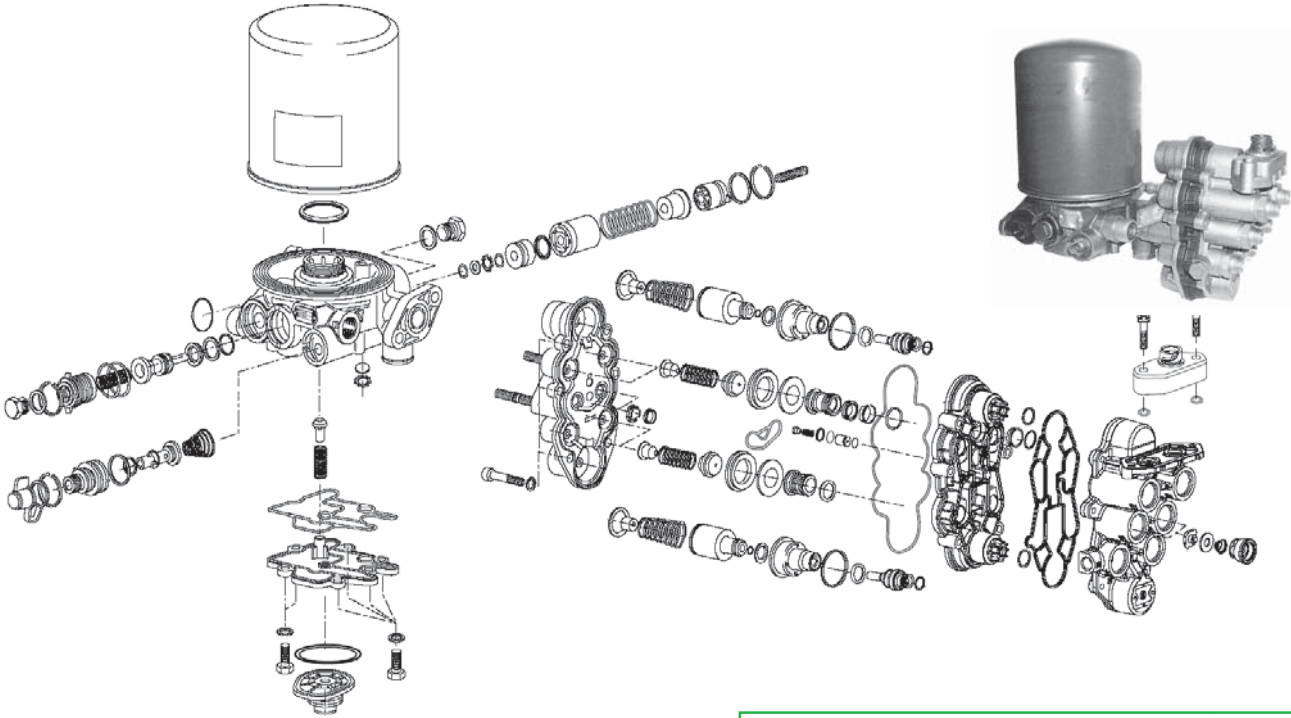
Protection Valve Entegredated Air Dryer Valve
Dağıtıcı Entegreli Kurutucu Valf

80.558.00.2 II 32581 / 008 - II 36251 / 008



80.558.01.2

II 32581 / 0051

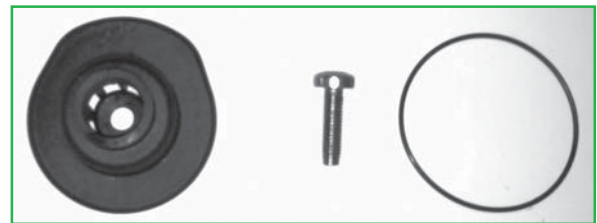

80.558.04.2

I 36251 / 0061

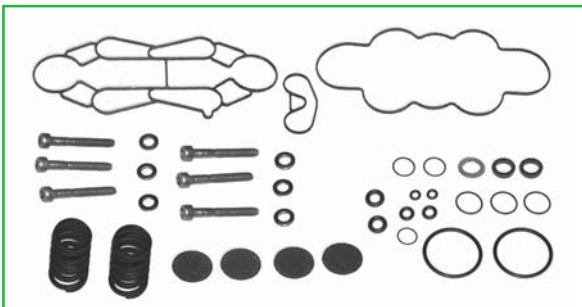

80.558.02.2 II 37680 / 008 - II 37680 / 0051

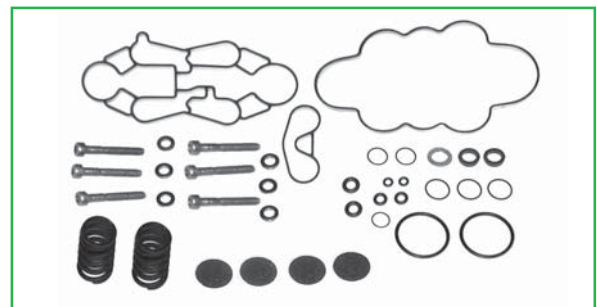

80.558.03.2

II 37680 / 004

80.559

Protection Valve Entegredated Air Dryer Valve
Dağıtıcı Entegreli Kurutucu Valf



80.559.00.2

932 400 000 2

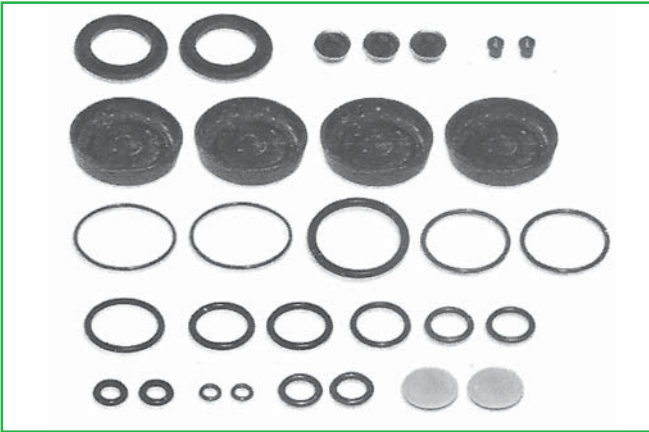

80.559.01.2

932 705 *** 2

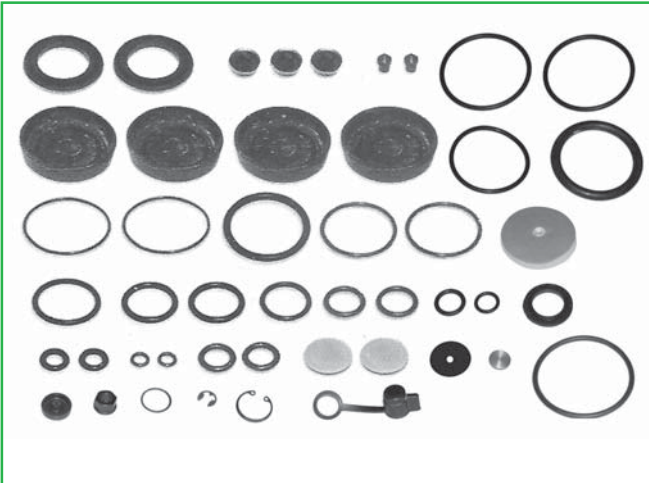

80.559.02.2

932 705 *** 2



80.559.03.2

934 705 920 2

80.557

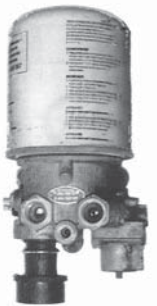
Air Dryer Valve
Kurutucu Valfi

80.557.00.2

1 487 010 316



80.557.01.2

1 487 010 317



80.557.02.2

1 487 010 ***

80.654

Air Dryer Valve
Kurutucu Valfi

432 511 *** 0

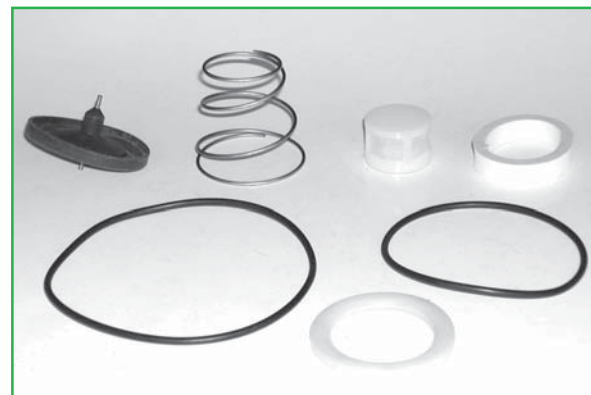

80.654.00.2

432 511 000 2

80.652

Air Dryer Valve
Kurutucu Valfi

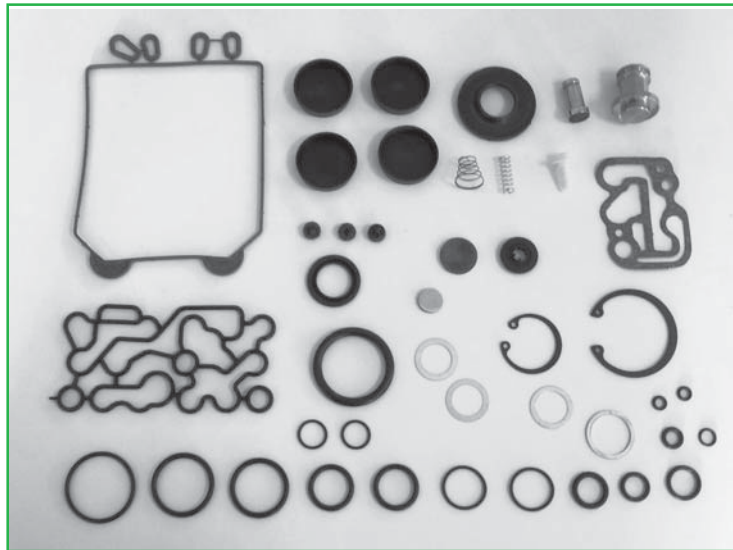
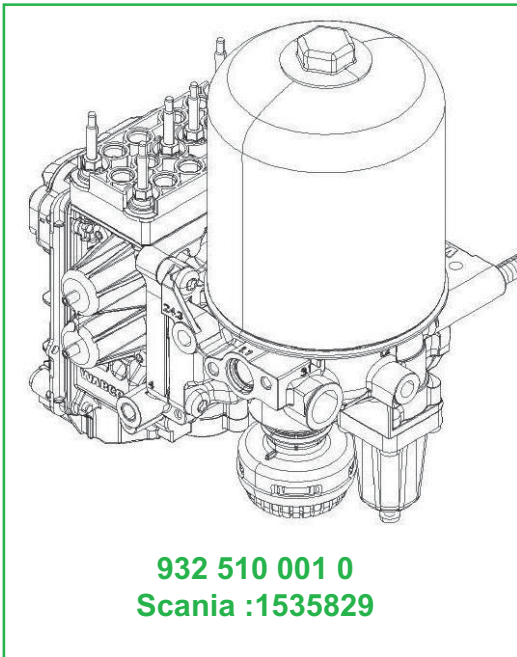

932 510 95* 2

80.662

Air Dryer Valve
Kurutucu Valfi

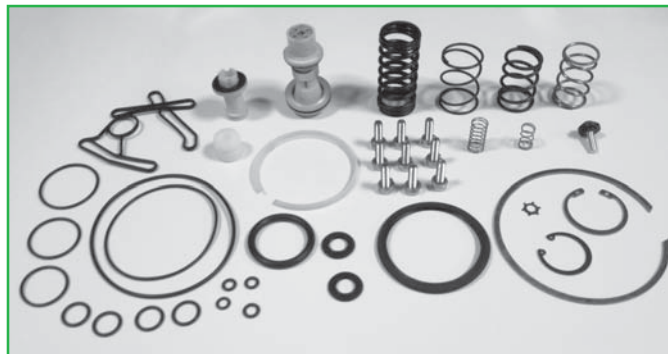

80.800

Air Dryer Valve
Kurutucu Valfi



EL 1100

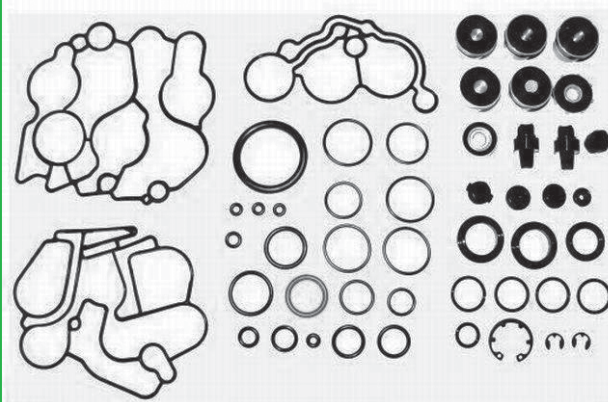

80.800.00.2

K004613

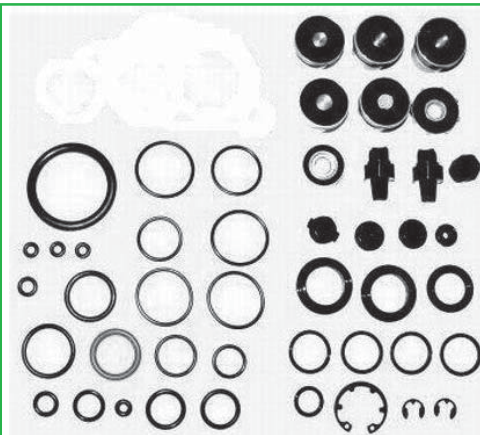

80.800.01.2

80.801

Air Dryer Valve
Kurutucu Valfi



ZB 4440

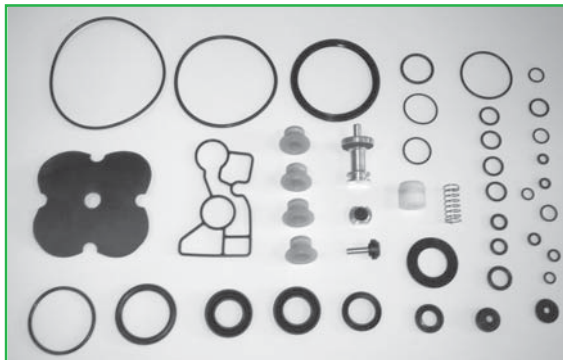

80.801.00.2



80.801.01.2

80.802

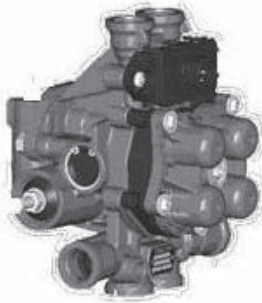
Air Dryer Valve
Kurutucu Valfi

AE 4800

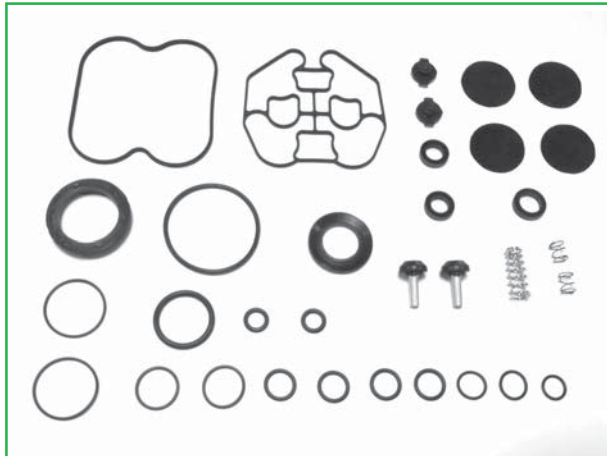

80.802.00.2

90

CLUTCH SERVOS

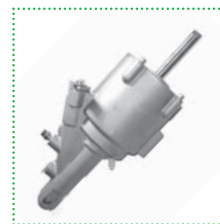
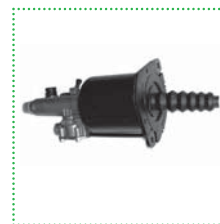

90.551

 Clutch Servo
 Debriyaj Alt Merkezi

1



2

İFN No	Ref. No	Fig.	Diameter	Stroke	Notes	Repair Kit
90.551.111.0	970 051 111 0	2	Ø 80,5	85	MAN F80 / F81	90.551.00.2 / 970 051 905 2
90.551.129.0	970 051 129 0	1	Ø 80,5	85	DAF	90.551.07.2 / 970 051 910 2
90.551.102.0	970 051 102 0	1	Ø 80,5	67	DAF	90.551.01.2 / 970 051 904 2
90.551.114.0	970 051 114 0	1	Ø 80,5	67	DAF / ZF	90.551.01.2 / 970 051 904 2
90.551.137.0	970 051 137 0	1	Ø 80,5	85	MERCEDES	90.551.07.2 / 970 051 910 2
90.551.126.0	970 051 126 0	1	Ø 80,5	67	IVECO	90.551.01.2 / 970 051 904 2
90.551.135.0	970 051 135 0	1	Ø 80,5	85	MERCEDES	90.551.07.2 / 970 051 910 2
90.551.136.0	970 051 136 0	2	Ø 80,5	85	DAF	90.551.10.2 / 970 051 913 2
90.551.150.0	970 051 150 0	2	Ø 80,5	85	DAF	90.551.07.2 / 970 051 910 2
90.551.156.0	970 051 156 0	2	Ø 80,5	85	NEOPLAN / ZF	90.551.07.2 / 970 051 910 2
90.551.169.0	970 051 169 0	1	Ø 80,5	85	NEOPLAN / ZF	90.551.07.2 / 970 051 910 2
90.551.204.0	970 051 204 0	1	Ø 80,5	24	IVECO	90.551.08.2 / 970 051 919 2
90.551.205.0	970 051 205 0	1	Ø 80,5	26	IVECO	90.551.11.2 / 970 051 907 2 Pentosin

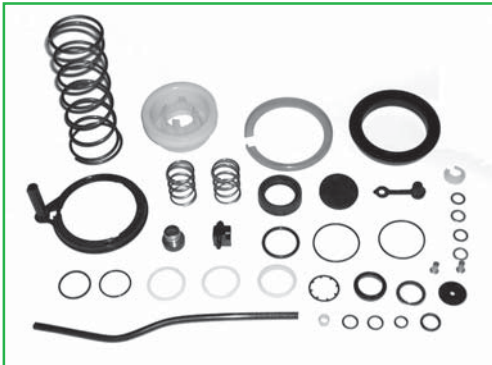
90.551.00.2

970 051 905 2

 FOR:
 970 051 111 0

90.551.06.2

970 051 914 2

 FOR:
 970 051 104 0

90.551.07.2

970 051 910 2

 FOR:
 970 051 129 0 970 051 210 0
 970 051 135 0 970 051 211 0
 970 051 137 0 970 051 220 0
 970 051 150 0
 970 051 169 0
 970 051 177 0
 970 051 183 0

90.551

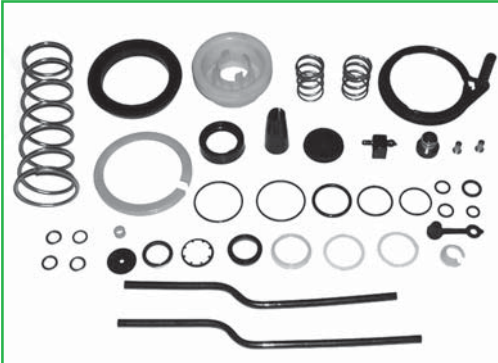
Clutch Servo
Debriyaj Alt Merkezi
**90.551.01.2**

970 051 904 2

FOR:
 970 051 102 0
 970 051 114 0
 970 051 126 0
 970 051 201 0
 970 051 204 0
 970 051 206 0

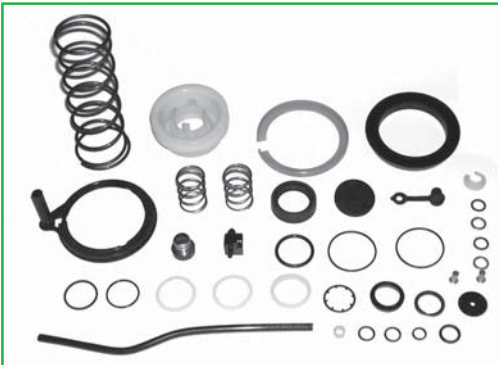
**90.551.11.2**

970 051 907 2

FOR:
 970 051 200 0
 970 051 205 0

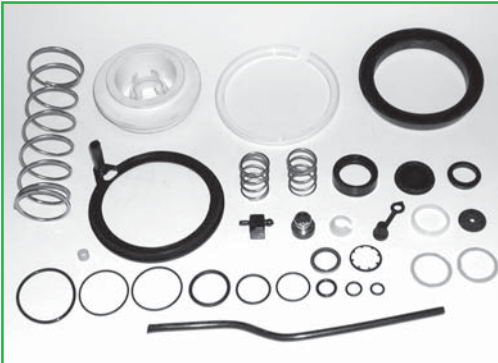
**90.551.09.2**

970 051 917 2

FOR:
 970 051 151 0
 970 051 162 0
 970 051 190 0

Ø 90,5



90 551

 Clutch Servo
 Debriyaj Alt Merkezi

1



2

İFN No	Ref. No	Fig.	Diameter	Stroke	Notes	Repair Kit
90.551.107.0	970 051 107 0	1	Ø 105	58	SCANIA 142,143	90.551.02.2 / 970 051 906 2
90.551.124.0	970 051 124 0	1	Ø 105	58	RVI	90.551.02.2 / 970 051 906 2
90.551.127.0	970 051 127 0	1	Ø 105	85	IVECO	90.551.02.2 / 970 051 906 2
90.551.128.0	970 051 128 0	1	Ø 105	58,5	MERCEDES	90.551.02.2 / 970 051 906 2
90.551.132.0	970 051 132 0	2	Ø 105	85	MAN F90	90.551.05.2 / 970 051 911 2
90.551.152.0	970 051 152 0	2	Ø 105	85	ZF	90.551.05.2 / 970 051 911 2
90.551.163.0	970 051 163 0	1	Ø 105	85	MERCEDES	90.551.12.2 / 970 051 954 2
90.551.164.0	970 051 164 0	1	Ø 105	85	MERCEDES	90.551.13.2 / 970 051 945 2
90.551.165.0	970 051 165 0	1	Ø 105	85	ZF	90.551.03.2 / 970 051 944 2
90.551.176.0	970 051 176 0	1	Ø 105	85	ZF	90.551.14.2 / 970 051 950 2
90.551.182.0	970 051 182 0	1	Ø 105	58,5		90.551.02.2 / 970 051 906 2
90.551.209.0	970 051 209 0	1	Ø 105	26	RVI	90.551.04.2 / 970 051 909 2

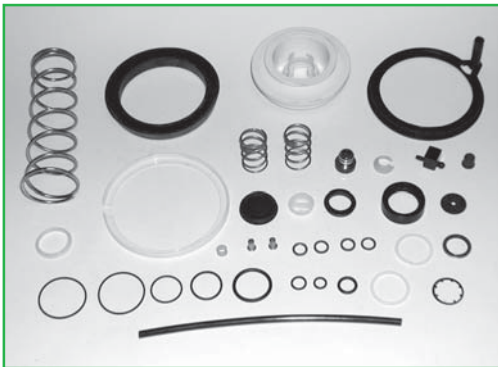
90.551.02.2

970 051 906 2

FOR:

 970 051 107 0
 970 051 124 0
 970 051 127 0
 970 051 182 0
 970 051 203 0
 970 051 207 0
 970 051 208 0
 970 051 209 0

90.551.03.2

970 051 944 2

FOR:

 970 051 165 0
 970 051 171 0

90.551

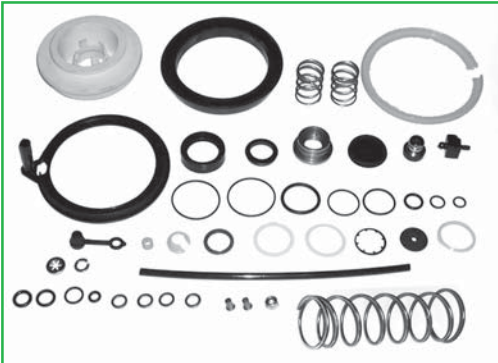
Clutch Servo
Debriyaj Alt Merkezi
**90.551.05.2**

970 051 911 2

FOR:

970 051 132 0

970 051 152 0

970 051 154 0

970 051 157 0

970 051 217 0

90.629

Clutch Servo
Debriyaj Alt Merkezi

IFN NO	Ref No	Notes
90.629.131.0	970 051 131 0	MERCEDES

**90.629.00.2**

970 051 903 2

FOR

970 051 131 0

Short Piston

**90.629.01.2**

970 051 002 2

FOR

970 051 113 0

Long Piston



90.672

 Clutch Servo
 Debriyaj Alt Merkezi

1

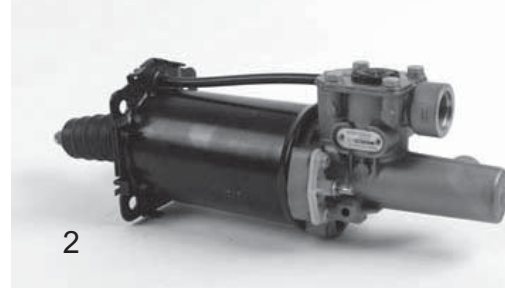

2

İFN No	Ref. No	Fig.	Diameter	Stroke	Notes	Repair Kit
90.672.307.0	970 051 307 0	1	Ø 100	85	MAN	90.672 00.2 / 970 051 943 2
90.672.405.0	970 051 405 0	1	Ø 100	85	MERCEDES	90.672 03.2 / 970 051 949 2
90.672.406.0	970 051 406 0	2	Ø 75	85	MAN	90.672 01.2 / 970 051 952 2
90.672.407.0	970 051 407 0	1	Ø 100	85	ZF	90.672 00.2 / 970 051 943 2
90.672.414.0	970 051 414 0	1	Ø 100	85	MAN	90.672 04.2 / 970 051 961 2
90.672.423.0	970 051 423 0	1	Ø 100	85	MAN, DAF	90.672 04.2 / 970 051 961 2
90.672.424.0	970 051 424 0	1	Ø 100	85	ZF	90.672 04.2 / 970 051 961 2
90.672.431.0	970 051 431 0	1	Ø 100	85	MERCEDES	90.672 05.2 / 970 051 974 2
90.672.438.0	970 051 438 0	1	Ø 100	75	RVI	90.672 00.2 / 970 051 943 2

90.672.00.2

970 051 943 2

FOR:

970 051 107 0

970 051 124 0

970 051 127 0

970 051 182 0

970 051 203 0

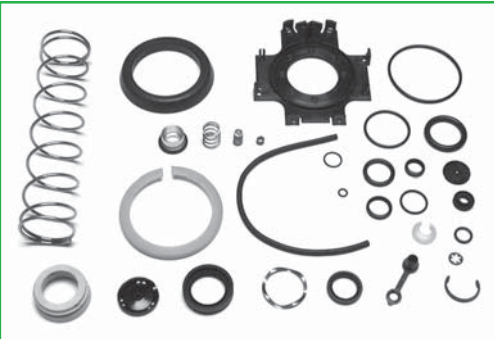

90.672.01.2

970 051 952 2

FOR:

970 051 406 0

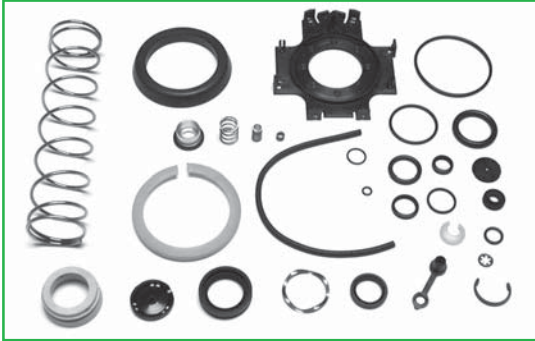
90.672

Clutch Servo
Debriyaj Alt Merkezi
**90.672.02.2**

970 051 970 2

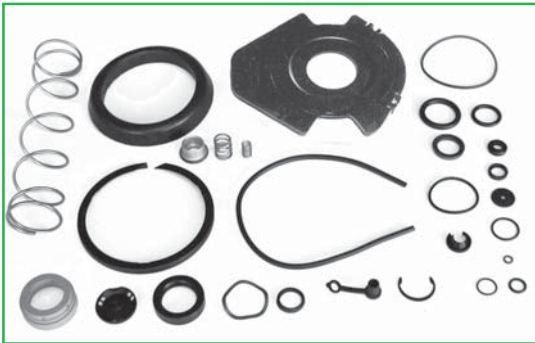
 FOR:
 970 051 429 0
 970 051 430 0
 970 051 435 0
**90.672.03.2**

970 051 949 2

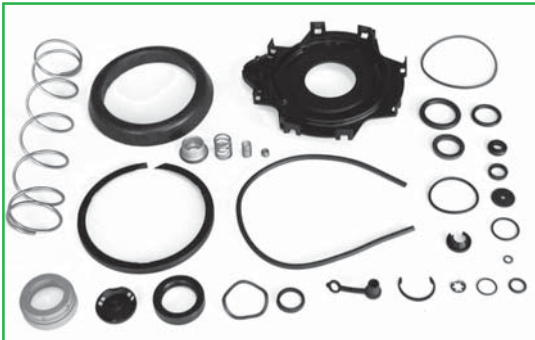
 FOR:
 970 051 405 0
**90.672.04.2**

970 051 961 2

 FOR:
 970 051 414 0
 970 051 424 0
 970 051 423 0
 970 051 418 0
**90.672.05.2**

970 051 974 2

 FOR:
 970 051 431 0

90.669

 Clutch Servo
 Debriyaj Alt Merkezi

IFN NO	Ref No	Notes
90.669.158.0	970 051 158 0	MERCEDES
90.669.159.0	970 051 159 0	MERCEDES



90.669.00.2 970 051 916 2

 FOR:
 970 051 146 0
 970 051 147 0
 970 051 158 0
 970 051 159 0

90.669.01.2 970 051 918 2

 FOR:
 970 051 161 0

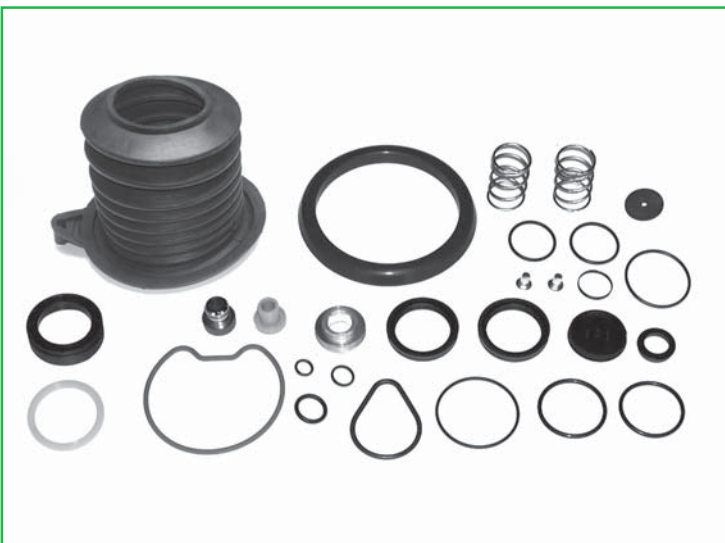
90.669.02.2 970 051 *** 2

 90.669.00.2 +
 Boot

90.669.03.2 Service Kit

 FOR:
 970 051 146 0
 970 051 147 0
 970 051 158 0
 970 051 159 0

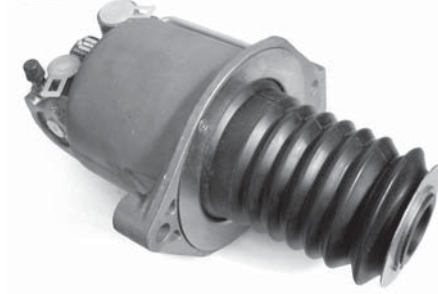
90.670

Clutch Servo
Debriyaj Alt Merkezi

IFN NO	Ref No	Notes
90.670.00.0	VG 3361	MERCEDES



90.670.00.2

II 14195 / 008

90.661

Clutch Servo
Debriyaj Alt Merkezi

IFN NO	Ref No	Notes
90.661.00.0	APGA 1605	BMC, DODGE, MERCEDES, VOLVO

90.661.00.2
 GA 29317

90.661.01.2
 GA 293**

With Piston

90.553
**Clutch Servo
Debriyaj Alt Merkezi**

IFN NO	Ref No	Stroke	Dimension	Notes
90.553.00.0	VG 3200	84	Ø 75	MAN, IVECO
90.553.04.0	VG 3204	84	Ø 75	IVECO
90.553.62.0	VG 3262	80	Ø 75	MAN

90.553.00.2
1 84613

 FOR:
 VG 3200
 VG 3204
 VG 3262
 VG 3265

90.553.01.2
1 93581

 Half Kit
 Yarım Takım

90.553.02.2
*1 846***

Full Kit

90.553.06.2
*1 846***

Common Kit

90.553

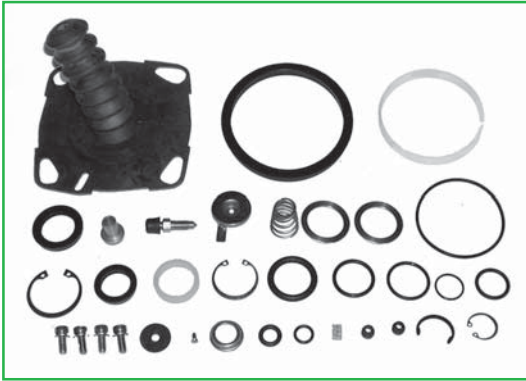
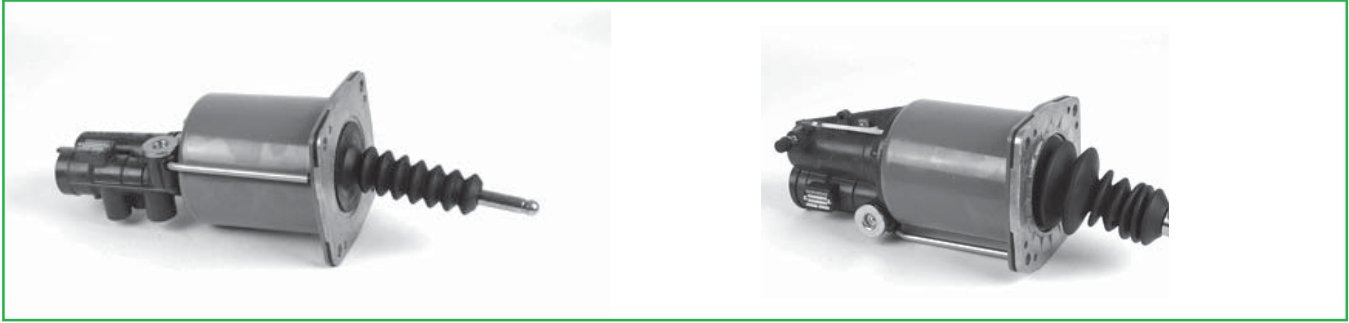
Clutch Servo
Debriyaj Alt Merkezi
**90.553.03.2**

/ 90586

FOR:
 VG 3208
 VG 3209
 VG 3218
 VG 3224
 VG 3228
 VG 3229
 VG 3263

90.553.04.2

/ 88094

Half Kit / Yarım Takım

**90.553.05.2**

/ 905**

**90.553.07.2****Common Kit****90.553.11.2**

/ / 35696 / 008

90.666

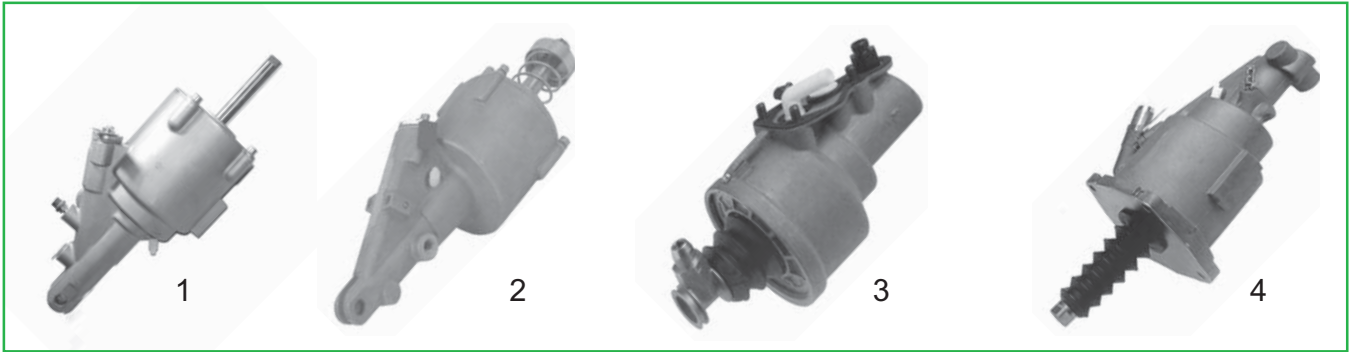
 Clutch Servo
 Debriyaj Alt Merkezi

İFN No	Ref. No	Fig.	Diameter	Notes
90.666.00.0	626392(1655639)	1	Ø 80	VOLVO F12
90.666.01.0	655435(1668501)	1	Ø 95	VOLVO FH 12
90.666.05.0	626639(1671953)	1	Ø 95	VOLVO FH 16
90.666.02.0	622107(360717)	2	Ø 100	SCANIA 92/112/142
90.666.04.0	625359(1421186)	3	Ø 100	SCANIA 94/114/124
90.666.06.0	628259(1443522)	4	Ø 80	DAF 95 XF
90.666.07.0	626785(1443520)	4	Ø 80	DAF
90.666.08.0	626786(1443521,1346866)	4	Ø 80	DAF SCANIA
90.666.09.0	626853(5010 245 752)	4	Ø 80	RENAULT VI
90.666.10.0	625384(5010 244 208)	4	Ø 80	RENAULT VI
90.666.11.0	622199(1331770)	4	Ø 100	SCANIA

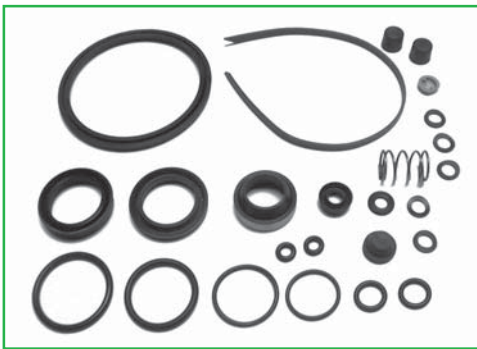
90.666.00.2

626703AM

 Replaces,
 627621AM
 271194

 For:
 VOLVO
 FL 10 / FL 6

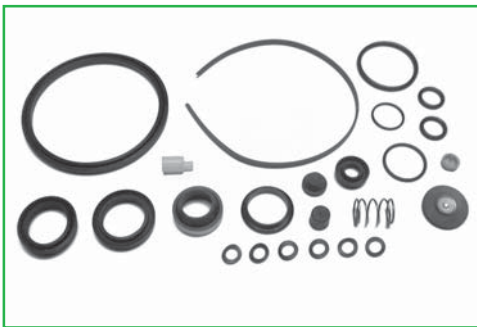
 For:
 626392AM
 1655639
 267321

90.666.01.2

627182AM

 Replaces,
 627618AM
 622095AM
 627366AM
 270586

 For:
 VOLVO
 FH 12

 For:
 626639AM
 1668501

90.666

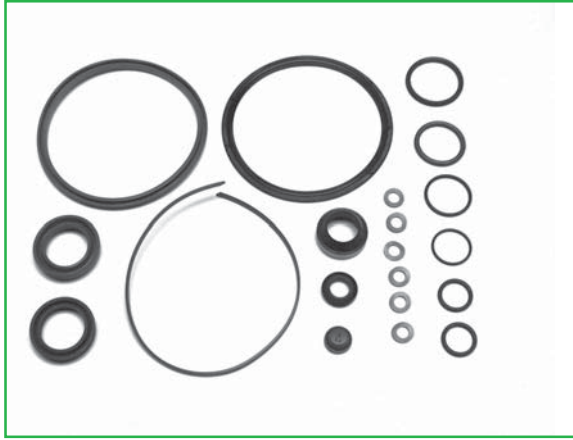
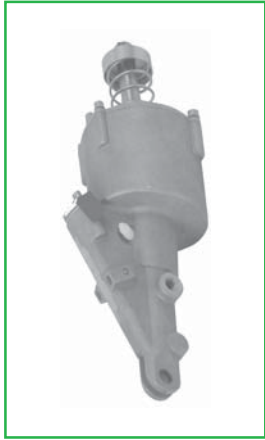
Clutch Servo
Debriyaj Alt Merkezi
**90.666.02.2**

622158AM

 Replaces
 622135AM
 622161AM

 For:
 SCANIA
 92 / 112 / 142

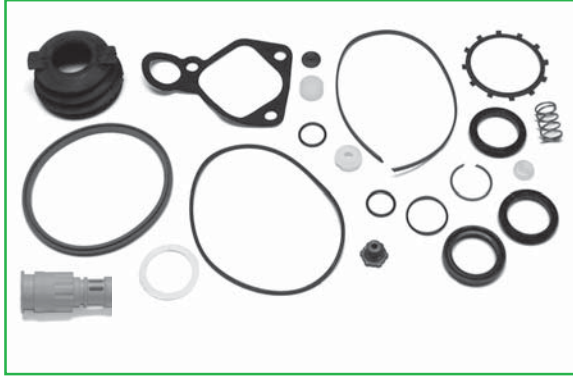
 For:
 622107AM
**90.666.03.2**

628131AM

 For
 625359AM
 627692AM

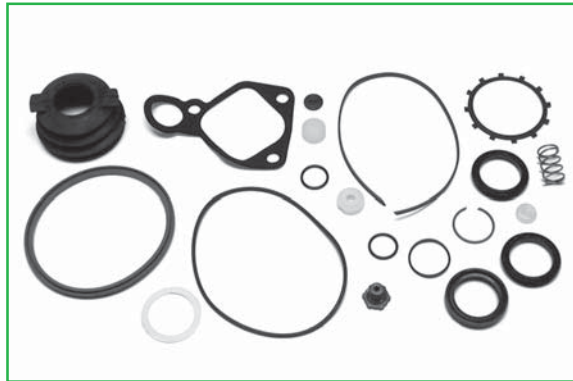
 For:
 SCANIA
 4 Series
**90.666.04.2**

628131AM

 For
 625359AM
 627692AM

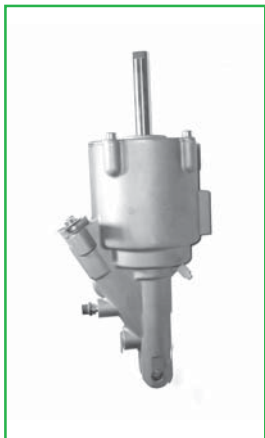
 For:
 SCANIA
 4 Series
**90.666.05.2**

628476AM

 For
 628492AM
 628493AM
 628494AM

 For:
 VOLVO
 FH / FM

90.625

Clutch Servo
Debriyaj Alt Merkezi



90.625.00.2

462 012 002 2

Ø 90



90.625.01.2

462 012 001 2

Ø 115

90.790

Clutch Servo
Debriyaj Alt Merkezi

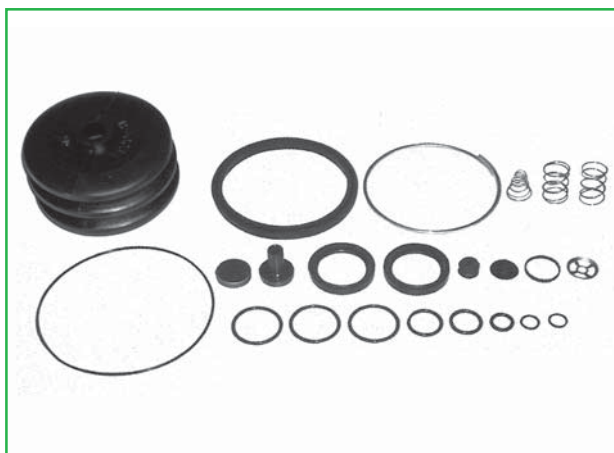
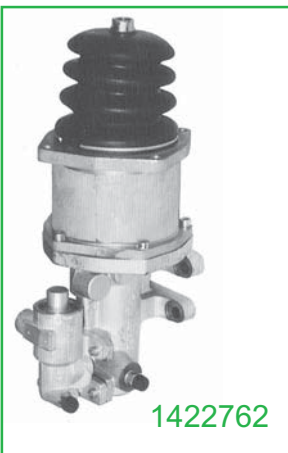

90.790.00.2

Benditalia

Replaces

1423081

1426591

1423079

100

PART 1 PRESSURE REGULATORS

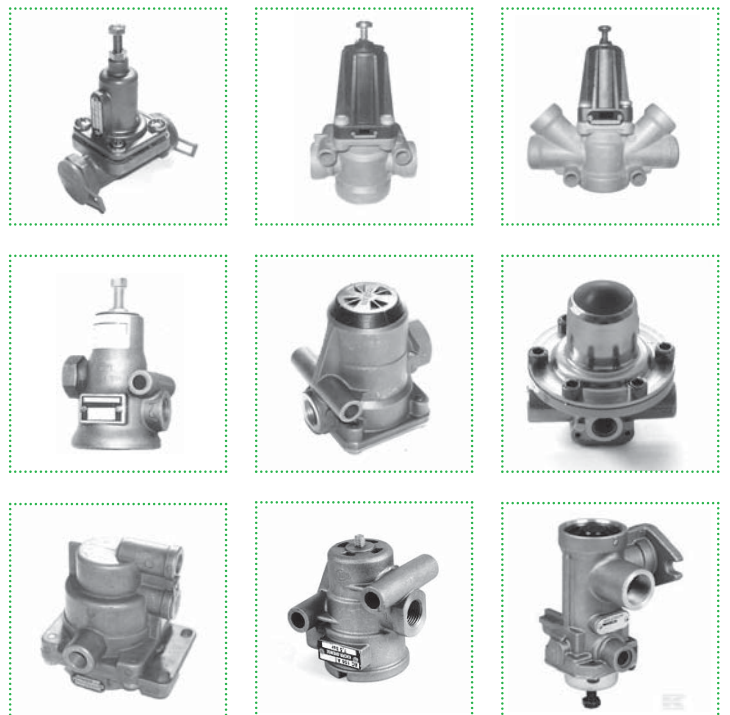

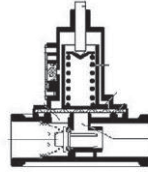
85.562
Pressure Regulator Valve
Basınç Ayar Valfi

A

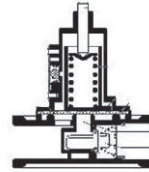

B

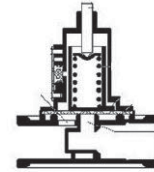

C

İFN No	Ref. No	Fig.	BAR	Repair Kit
85.562.124.0	434 100 124 0	B	5,5	IVECO, MAN, MERCEDES
85.562.120.0	434 100 120 0	B	3,5	IVECO, MAN, MERCEDES, RVI, VOLVO
85.562.121.0	434 100 121 0	B	4,0	IVECO, MAN, MERCEDES, RVI, DAF, SETRA
85.562.122.0	434 100 122 0	B	4,5	IVECO, MAN, MERCEDES, RVI, DAF
85.562.125.0	434 100 125 0	B	6,0	IVECO, MAN, MERCEDES, RVI, DAF, SETRA, SCANIA, VOLVO
85.562.104.0	434 100 104 0	B	5,5	MAN, MERCEDES
85.562.002.0	434 100 002 0	A	4,5	MAN, MERCEDES, DAF
85.562.004.0	434 100 004 0	A	5,3	MAN, DAF
85.562.003.0	434 100 003 0	A	5,5	MAN, MERCEDES, RVI
85.562.220.0	434 100 220 0	C	4,5	IVECO, MAN, MERCEDES, RVI, DAF
85.562.202.0	434 100 202 0	C	6,2	MERCEDES
85.562.221.0	434 100 221 0	C	5	IVECO, MAN, MERCEDES, VOLVO, DAF

85.562.00.2

434 100 009 2

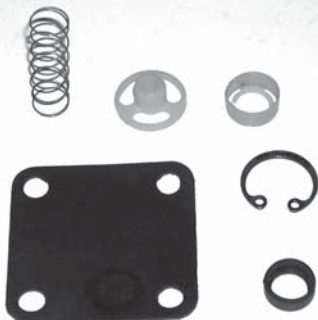
85.562.01.2

434 100 002 2

100.655

Reduction Valve
Basınç Düşürme Valfi
**100.655.00.2**

473 302 001 2

100.655.01.2

473 302 000 2

100.134

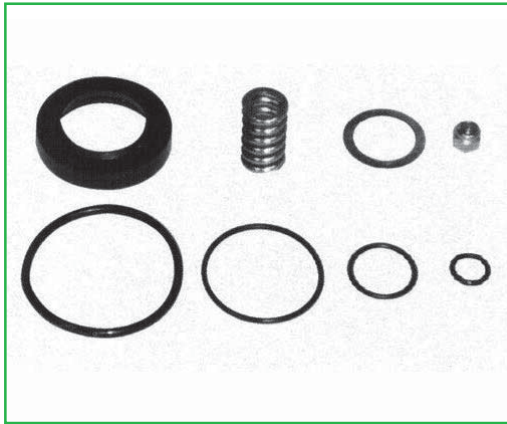
Pressure Regulator Valve
Basınç Ayar Valfi
**100.134.00.2**

76630701000

100.135

 Pressure Regulator Valve
 Basınç Ayar Valfi

İFN No	Ref. No	BAR	Vehicles
100.135.400.0	475 015 400 0	4,5	IVECO, MAN
100.135.001.0	475 015 001 0	7,4	MAN, MERCEDES, DEUTZ
100.135.004.0	475 015 004 0	3,5	MAN, MERCEDES, NEOPLAN, IVECO
100.135.045.0	475 015 045 0	7	DAF



100.135.00.2
 475 015 001 2

100.136

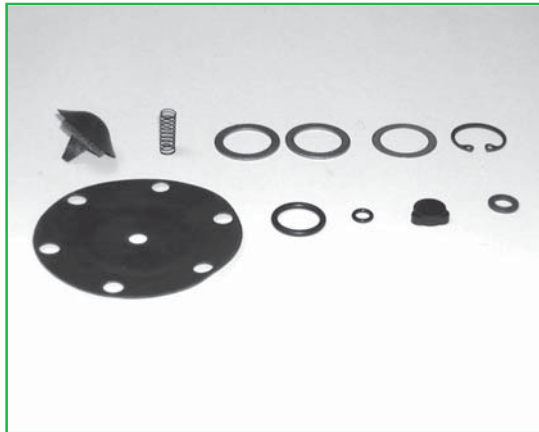
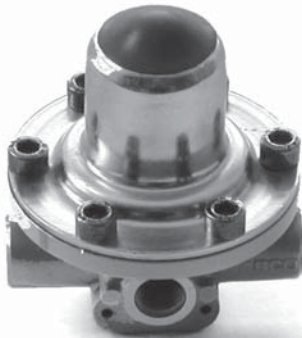
 Pressure Regulator Valve
 Basınç Ayar Valfi

100.136.00.2
 475 009 000 2

100.137

Pressure Regulator Valve
Basınç Ayar Valfi

İFN No	Ref. No	BAR	Vehicles
100.137.22.0	0 481 009 022	7,3	MAN, MERCEDES, VOLVO, SCANIA, DAF
100.137.29.0	0 481 009 029	8	MAN, MERCEDES, VOLVO, SCANIA, DAF
100.137.47.0	0 481 009 047	7,5	MAN, MERCEDES, VOLVO, SCANIA, DAF
100.137.55.0	0 481 009 055	8	MAN, MERCEDES, VOLVO, SCANIA, DAF

**100.137.00.2**

1 487 010 221

100.138

Pressure Regulator Valve
Basınç Ayar Valfi

2

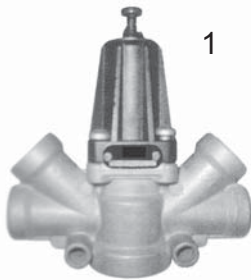

1

İFN No	Ref. No	Fig	Vehicles
100.138.400.0	475 010 400 0	1	MAN, DAF
100.138.200.0	475 010 200 0	2	SCANIA
100.138.313.0	475 010 313 0	2	MAN, SCANIA, IVECO, DAF
100.138.300.0	475 010 300 0	2	MAN

**100.138.00.2**

475 010 002 2

 Replaces / Yerine
 Geçer
 475 010 001 2
**100.138.01.2**

475 010 0** 2

100.139

 Pressure Regulator Valve
 Basınç Ayar Valfi

İFN No	Ref. No	BAR	Vehicles
100.137.22.0	0 481 009 022	7,3	MAN, MERCEDES, VOLVO, SCANIA,DAF
100.137.29.0	0 481 009 029	8	MAN, MERCEDES, VOLVO, SCANIA,DAF
100.137.47.0	0 481 009 047	7,5	MAN, MERCEDES, VOLVO, SCANIA,DAF
100.137.55.0	0 481 009 055	8	MAN, MERCEDES, VOLVO, SCANIA,DAF

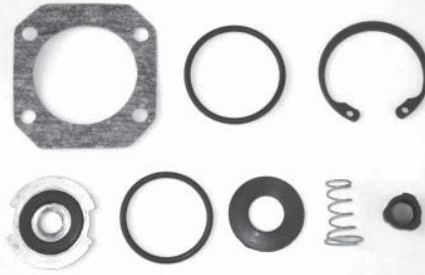

100.139.00.2
 475 010 000 2

100.265

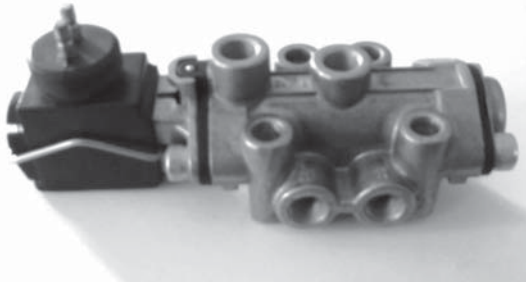
 Directional Control Valve
 Yönlendirici Valf

100.265.00.0

1334037 SCANIA
 1488083

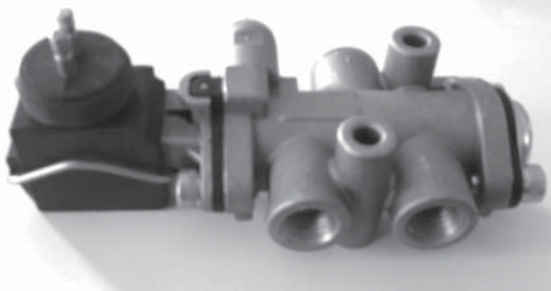

100.265.01.0

1457275 DAF Screw Type

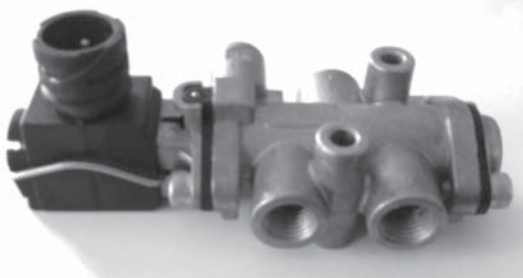

100.265.02.0

1457276 DAF Bayonet
 Type

100

PART 2 SELENOID VALVES

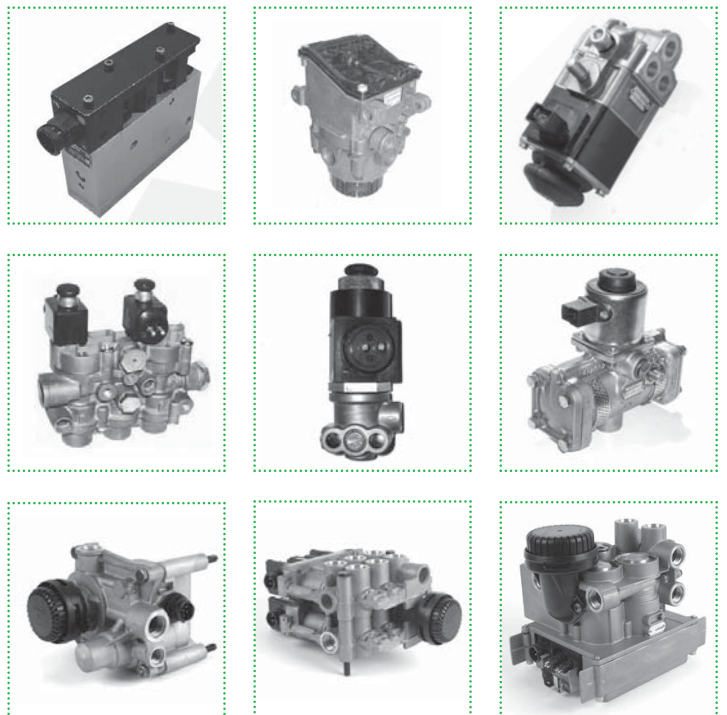

100.620

 Door Selenoid Valve
 Kapı Otomatığı Valfi

İFN No	Ref. No	V	Vehicles
100.620.480.0	472 017 480 0	24	MERCEDES, IVECO, NEOPLAN,MAN----BUSES
100.620.481.0	472 017 481 0	12	MERCEDES, IVECO, MAGIRUS-MINI BUSES

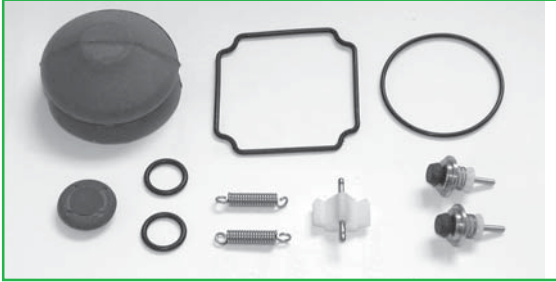

100.620.00.2
472 017 000 2

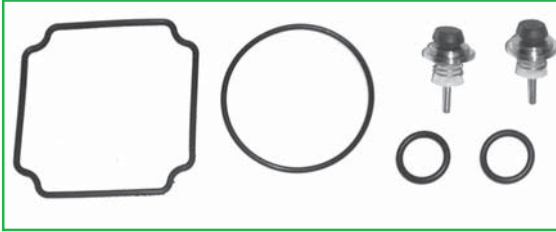

100.620.01.2
475 010 *** 2

100.617

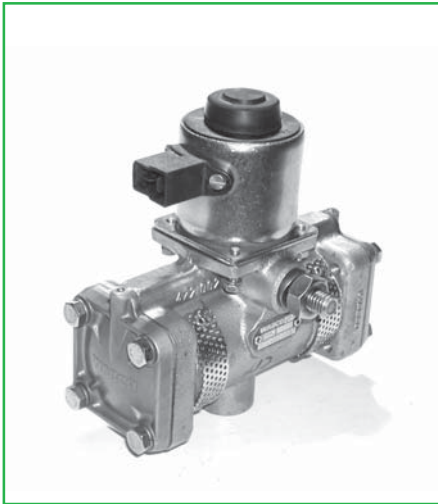
 Door Selenoid Valve
 Kapı Otomatığı Valfi

100.617.00.2
472 002 009 2



100.617.01.2
472 002 *** 2

100.266

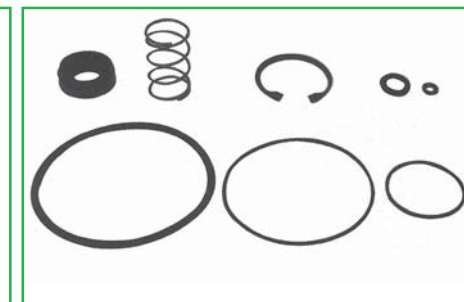
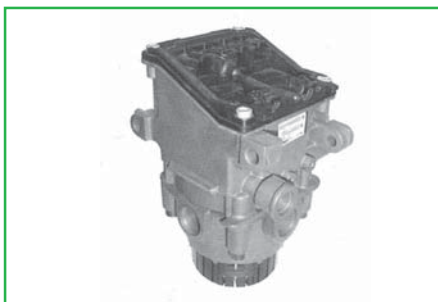
 EBS Channel Module
 EBS Kanal Modülü

100.266.00.2

For
0 486 203 030

100.267

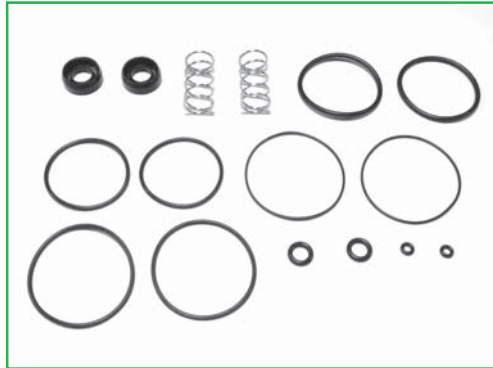
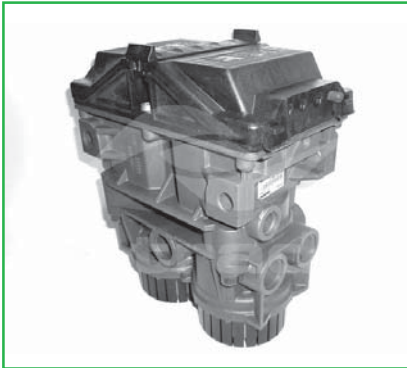
EBS Channel Module
EBS Kanal Modülü
100.267.00.2
 For
 0 486 204 004

100.619

ECAS Selenoid Valve
ECAS Selenoid Valfi
100.619.00.2 472 900 002 2
 For:

472 900 051 0	472 900 005 0
472 900 102 0	472 900 006 0
472 900 103 0	472 900 008 0
472 900 105 0	472 900 050 0
472 900 001 0	472 900 101 0

100.619.01.2 472 900 009 2
 For:

472 900 053 0	472 900 062 0
472 900 055 0	472 900 063 0
472 900 056 0	472 900 065 0
472 900 060 0	
472 900 061 0	



100.585

Selenoid Valve
Selenoid Valfi

IFN No	Ref. No	V	Vehicles
100.585.908.0	472 123 908 0	24	
100.585.107.0	472 123 107 0	12	MERCEDES, IVECO, DAF, RVI
100.585.109.0	472 123 109 0	24	

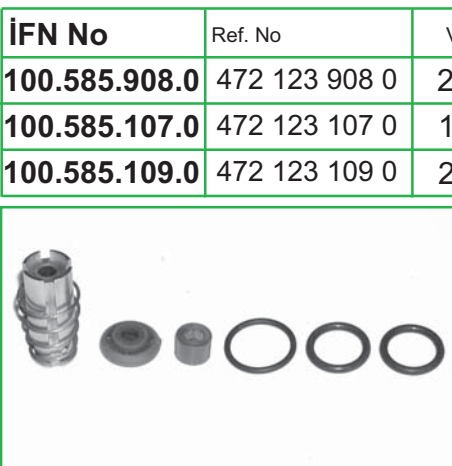
100.585.00.2 472 123 000 2

100.613

Trailer ABS Control Valve
Dorse ABS Kontrol Valfi

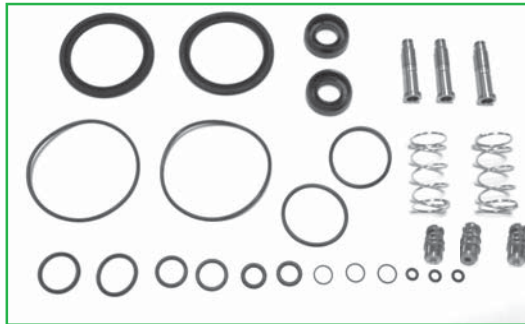
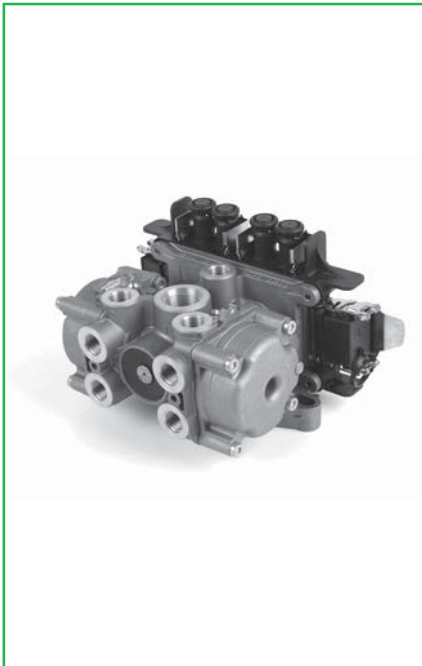

100.613.00.2

For
400 500 081 0

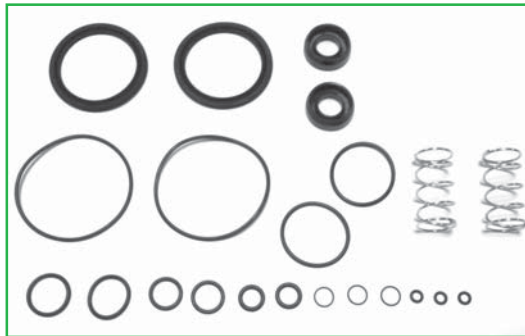

100.613.01.2

For
400 500 081 0

100.614

ECAS Selenoid Valve
ECAS Selenoid Valfi

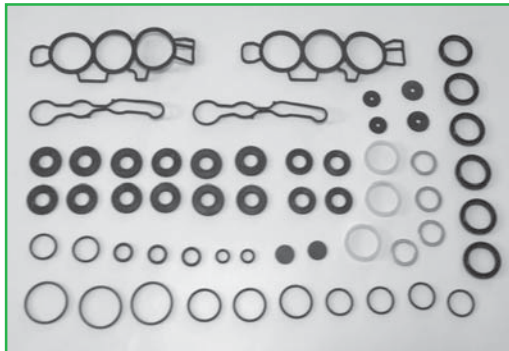
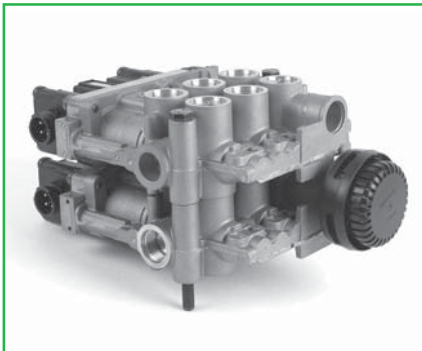

100.614.00.2

472 905 004 2

For
472 905 111 0

MAN TGA, DAF 95 XF
MERCEDES ACTROS

100.639

EBS Axle Modulator
EBS Aks Modulatorü

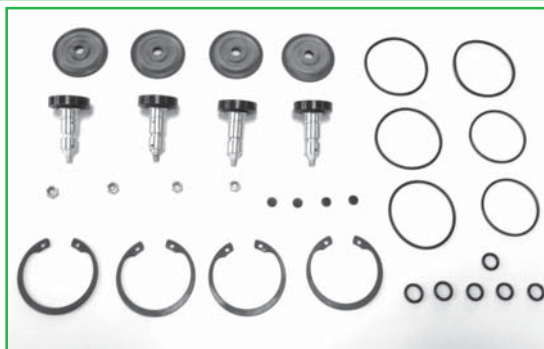
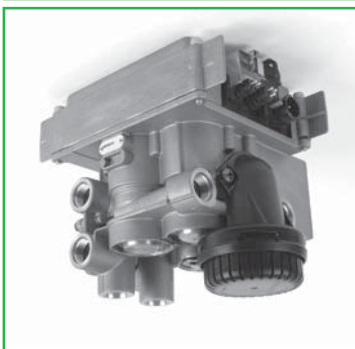

100.639.00.2

For
480 103 011 0

100.618

ELC Valve
ELC Seviye Valfi
100.618.00.2

1 507 010 022

100.618.01.2

Servis Kit

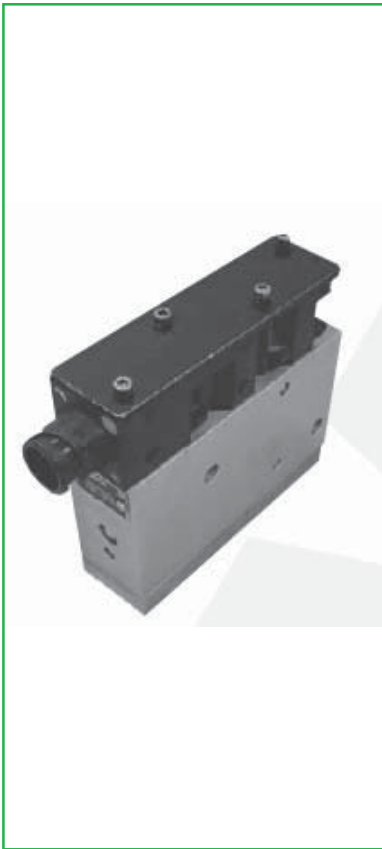

100.616

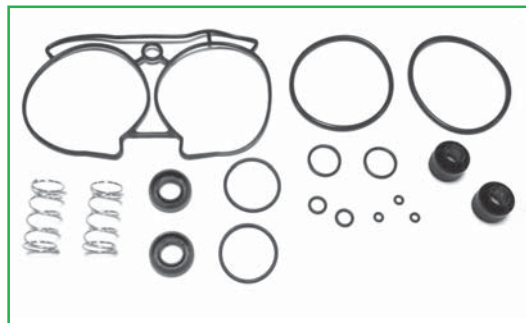
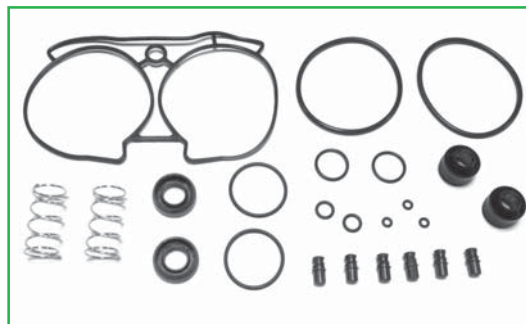
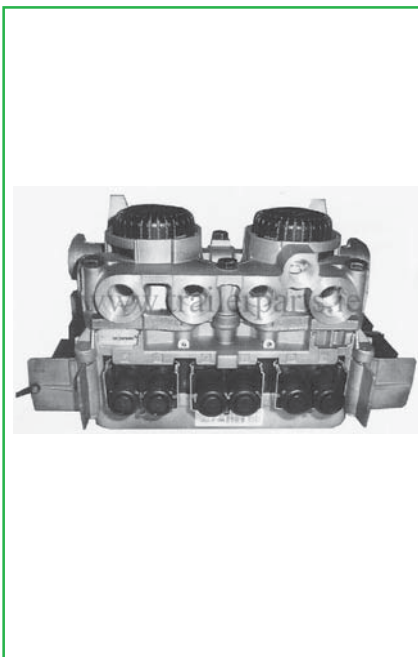
ELC Valve
ELC Seviye Valfi
100.616.00.2For
480 102 014 0**100.616.01.2**

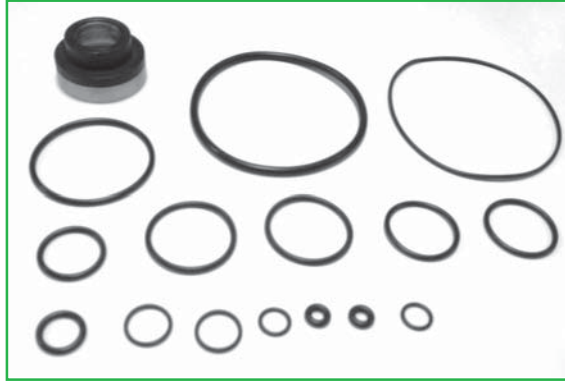
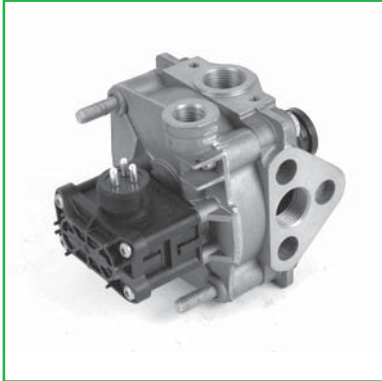
100.158
Directional Control Valve
Yönlendirici Valf

100.158.00.2
85.250
Quick Release Valve
Çabuk Tahliye Valfi

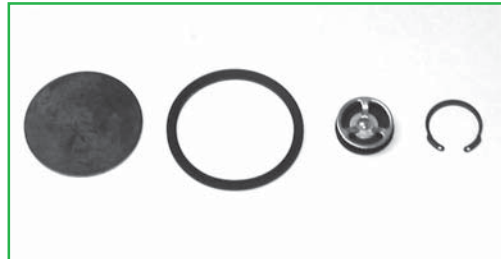
İFN No	Ref. No	V	Vehicles
100.620.480.0	472 017 480 0	24	MERCEDES, IVECO, NEOPLAN, MAN----BUSES
100.620.481.0	472 017 481 0	12	MERCEDES, IVECO, MAGIRUS-MINI BUSES

85.250.02.2
 973 500 000 2

100.653
Line Filter
Hava Hattı Filtresi

100.653.00.0 432 500 020 0 M22*1,5 / M22*1,5

100.360

Directional Control Valve
Yönlendirici Valf

100.360.00.0 463 036 000 0 M10*1 / M10*1 Mounting=M28*1,5

50.547

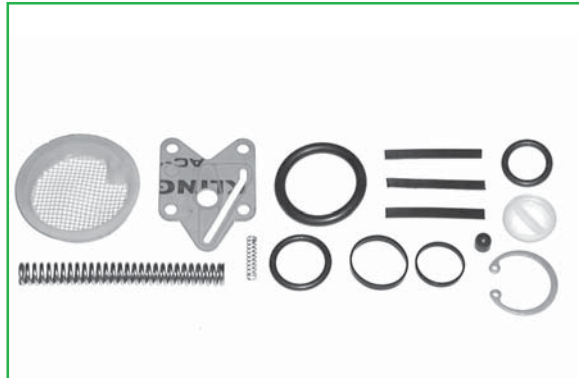
Anti Freeze Pump
Alkol Ventili

50.547.00.2
 I 85567

100.156

Directional Control Valve
Yönlendirici Valf

İFN No	Ref. No	Lenght	Vehicles
100.156.114.0	463 013 114 0	95,6	MERCEDES,VOLVO
100.156.110.0	463 013 110 0	46,9	MERCEDES, MAN, SETRA, NEOPLAN, SCANIA
100.156.112.0	463 013 112 0	37,9	IVECO, NEOPLAN, MERCEDES

100.575

Raise/Lower Electromagnetic Valve
Elektro Magnetik Hava Control Valfi

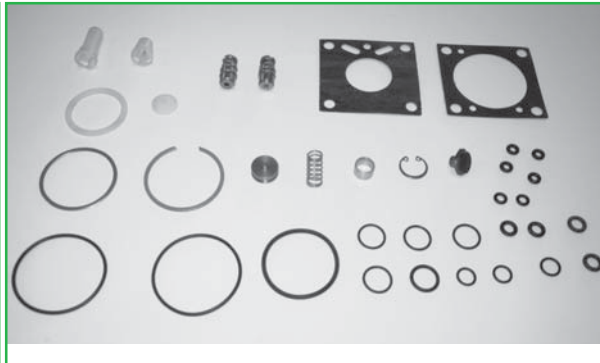
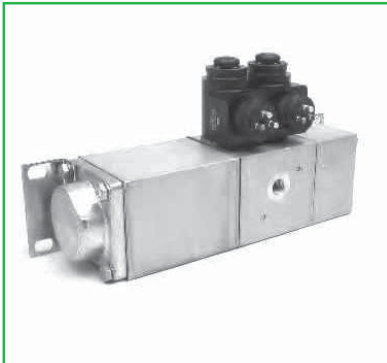

100.575.02.2

For
338 032 001

100.638

ABS Relay Valve
ABS Röle Valfi

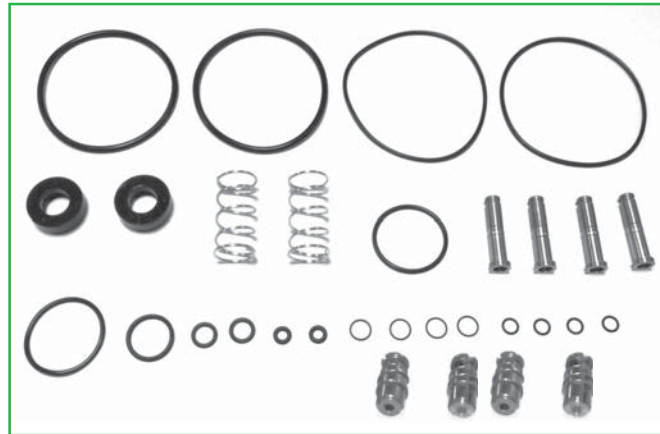

100.638.00.2

For
472 195 041 0

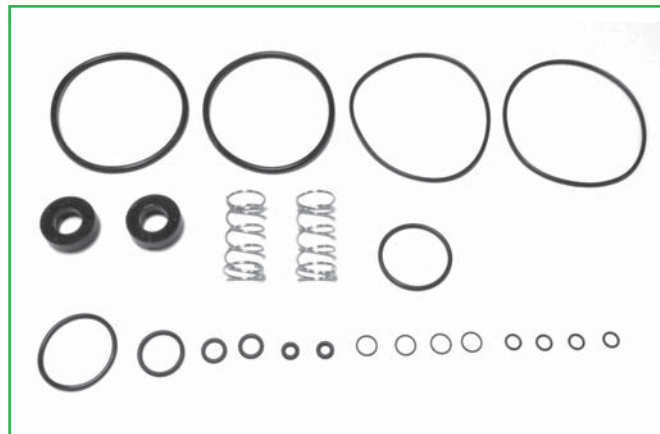

100.638.01.2

100.805

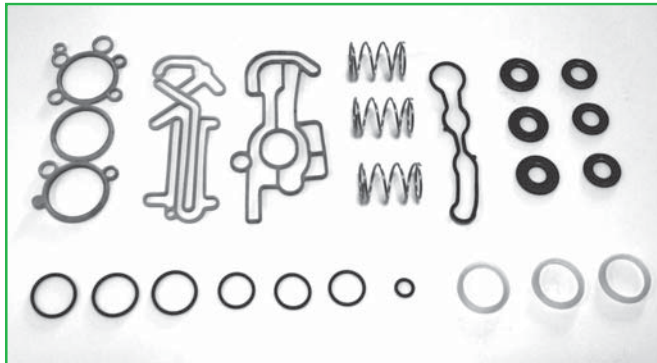
ECAS Selenoid Valve
ECAS Selenoid Valfi
**100.805.00.2**

472 880 920 2

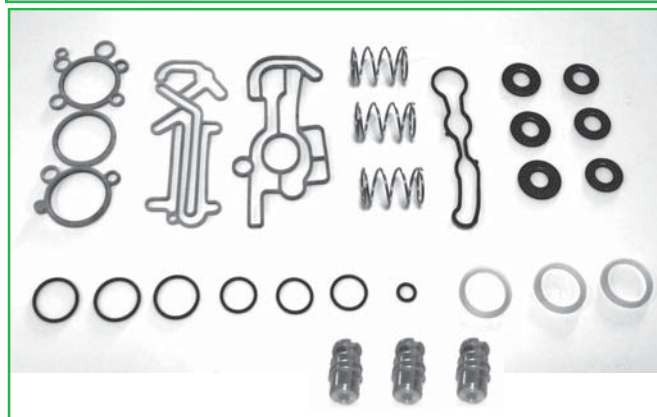
For
472 880 003 0**100.805.01.2**

472 880 920 2

For
472 880 003 0

100.806

EBS Modulator Valve
EBS Modülator Valfi

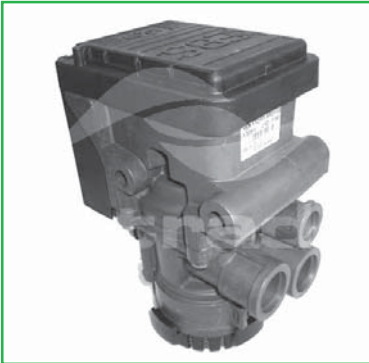

100.806.00.2

K000913

MAN 81521066041
81521066047



100.805.01.2

K000921

105

CALIPER REPAIR KITS

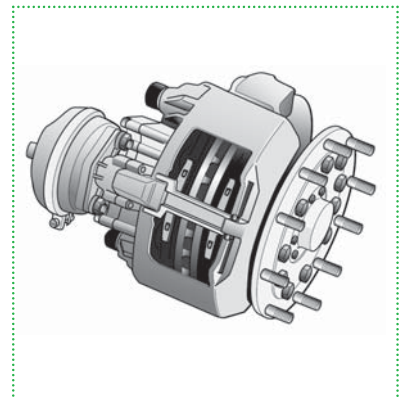

105.700

Caliper Repair Kits
Kaliper Tamir Takımları

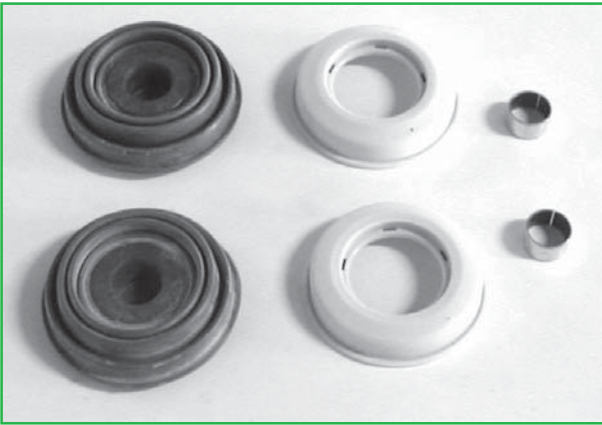

105.700.00.2

K001300

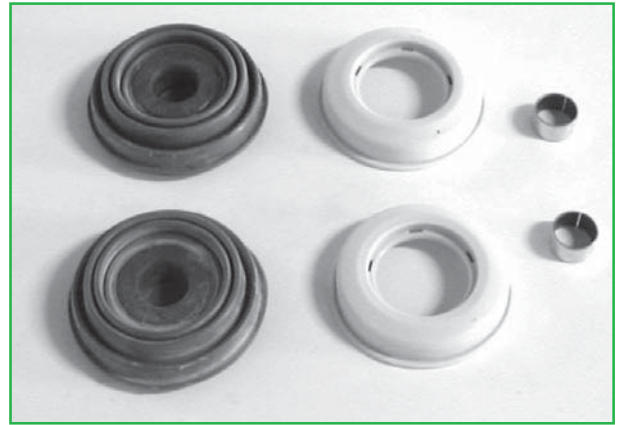

105.700.05.2

K000944



105.700.01.2

II 32809 / 0062



105.700.03.2

K000375

110

COMPRESSORS

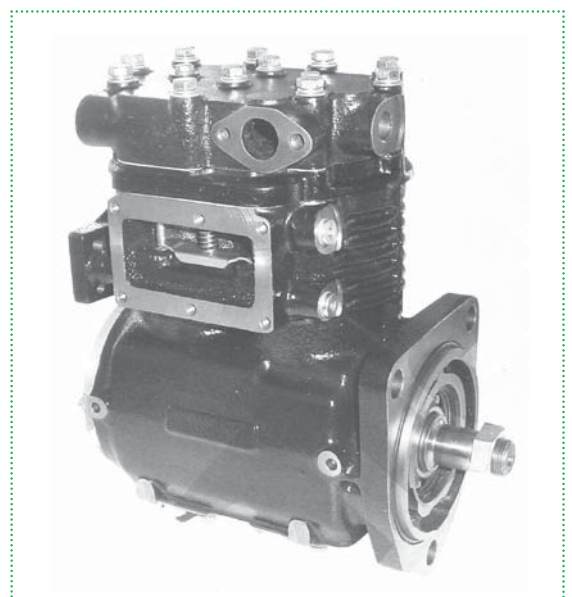

110.355

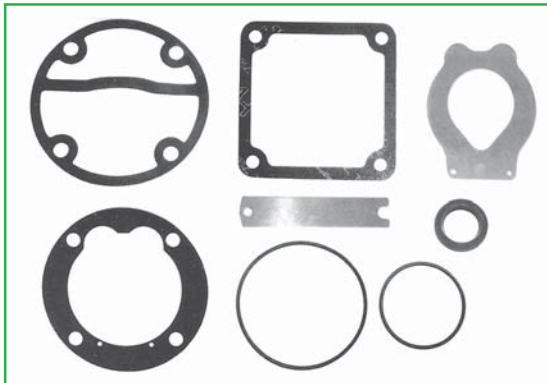
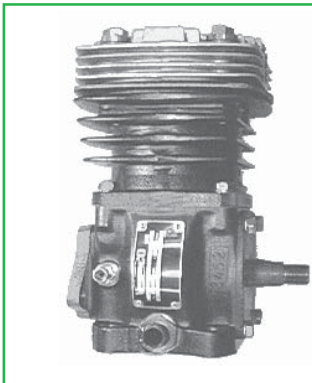
 Compressor
Kompresör

110.355.00.2

411 034 005 2

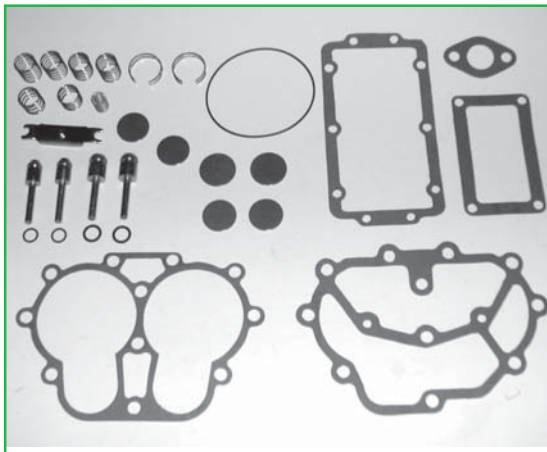
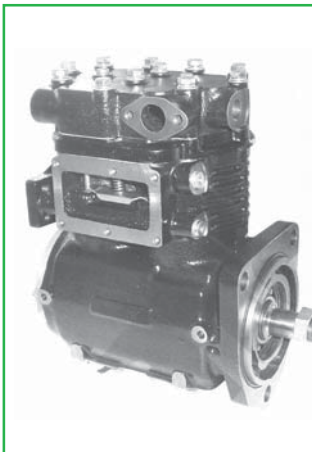
110.911

 Compressor
Kompresör

110.911.00.2

SK 2681/ 5 / 3090471

 For
 KZ.433.1
 KZ.996
 KZ.642
 KZ.966
 KZ.1228

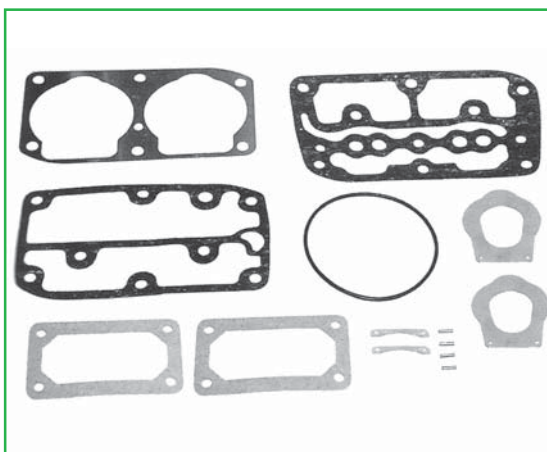
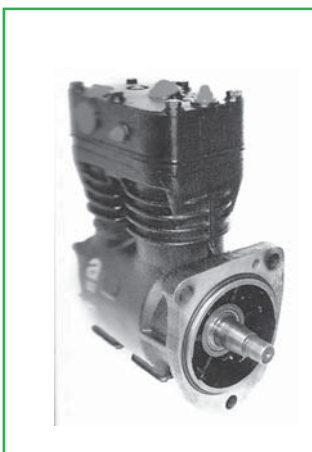
110.917

 Compressor
Kompresör

110.917.00.2

/ 86909 / 0061

 For
 LP 4812
 LP 4813
 LP 4814
 LP 4815

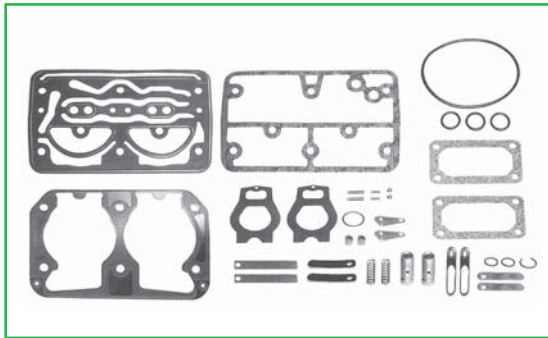
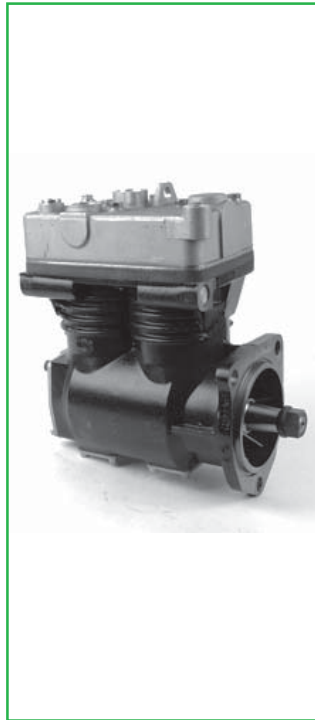
110.915

Compressor
Kompresör**110.915.00.2**

II 15992 / 0051

For
Ø 88

LP 4934	LP 4962
LP 4930	LP 4963
LP 4967	LP 4964
LP 4957	

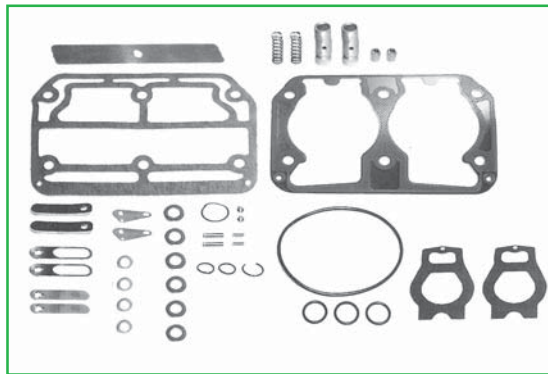
**110.915.01.2**

SEB 22545

For
Ø 75

LP 4825

110.918

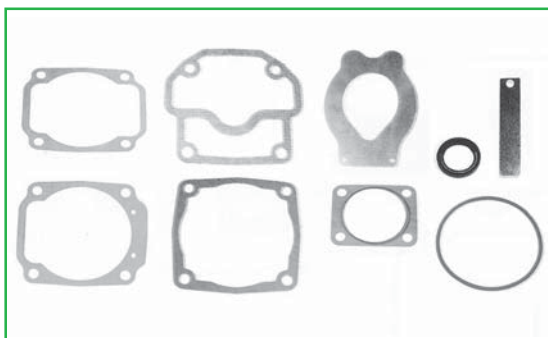
Compressor
Kompresör**110.918.00.2**

63784

For
Ø 88

LK 1806	LK 1901
LK 1808	LK 1900
LK 1813	
LK 1802	

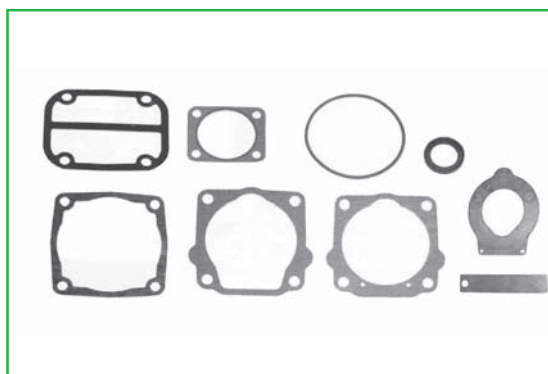
**110.918.01.2**

63736

For
Ø 75LK 15**
LK 13**

110.916

Compressor
Kompresör

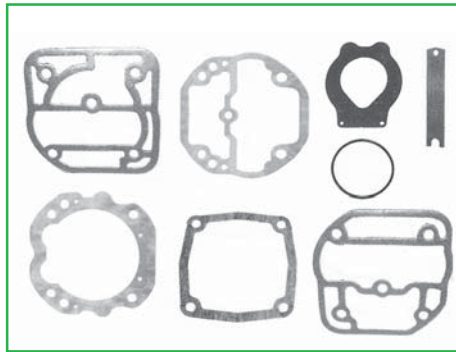
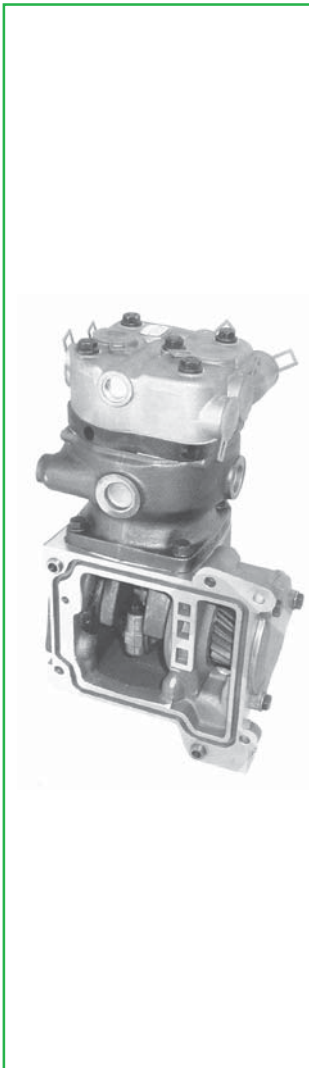

110.916.00.2

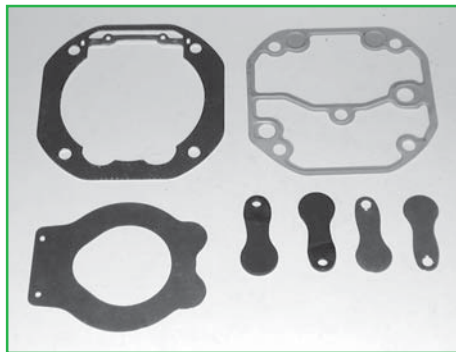

110.921.00.2

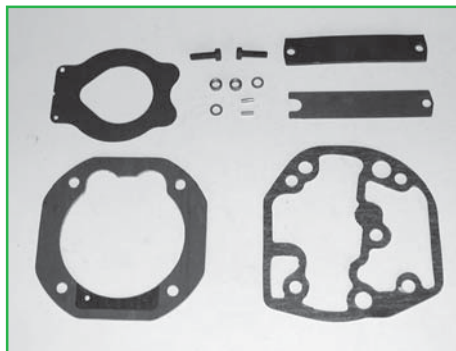

110.922.00.2